

MaxwellBeau

2020

Product List



We manufacture an extensive range of desks, boardroom tables, boardroom furniture, credenzas, storage, workstations and bespoke furniture.

All our office furniture is produced with quality and value in mind. Australian Made by our team in QLD



Our work tops can be made to virtually any size and shape in a huge range of plain and woodgrain colours, we can also implement cable entry holes and scallops.



Our Metal Frame tables are ideal for the office environment and are strong and durable, designed to meet a broad range of applications. We manufacture general purpose tables, coffee tables, desks, trolleys, training tables and high bars etc. which are available in a wide range of standard or custom sizes and shapes.



Work and learning spaces are not a one size fits all approach — every space has unique needs and requirements.

Our furniture offers a range for a number of areas and applications in and around the school or education centre.

MaxwellBeau Pty Ltd

Unit 8, 15 John Duncan Ct

Varsity Lakes QLD 4227

1300 654 833

info@maxwellbeau.com.au

STANDARD FEATURES -----

- AXIS 18 - 25mm Tops over 18mm Gables with matching 2mm Edging
- NEXUS 25 – 25mm Tops over 25mm Gables with matching 2mm Edging
- Slimline Satin Bow Chrome Handles - 96mm
- Height for desks, credenzas etc - 725mm
- Metal drawers – Desks - 450mm deep, Returns – 400mm deep
- Modesty Panel 270mm from floor
- Kick Rail – 60mm
- Cable entry size 80mm (60mm on REQUEST)
 - When ordering cable entry, please advise which side and position (user side, or visitor side)

PLEASE NOTE – Special Sized Standard Product (Length, Depth and/or Height) to be priced at next size up plus 10%

OTHER FEATURES at additional cost -----

- Adjustable Keyboards
- Pull out Keyboard
- Extra overhang on tops
- Flush Top with 2mm Edging overhang
- Gable cut-out for skirting
- Move standard modesty panel position
- Studio Handles - Square style handles
- 33mm Tops available – Please request a quote
- Production and supply of special orders or purpose made furniture.



STANDARD COLOUR CONFIGURATION UNLESS OTHERWISE REQUESTED -----

- Desks/Returns/Mobile Pedestals/Credenzas etc –
 - COLOUR A - TOP, DRAWER FRONTS, SHELVES, DOORS
 - COLOUR B - GABLES, BACK, KICK RAIL (Carcass)

STANDARD WOODGRAIN CONFIGURATION -----

- Woodgrains run vertical on gables, divisions
- Woodgrains run horizontal on shelves, tops, bases, drawer fronts, kickboards, modesty panels
- Woodgrains run horizontal on doors up to 900mm high
- Woodgrains run vertical on doors over 900mm high
- Woodgrains on bookcase backs run horizontal up to 1800h, vertical over 1800h.

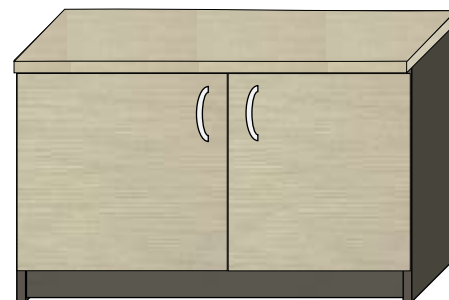

OTHER INFORMATION -----

- Pictures are for illustration purpose only.
- Laminex MDF Substrate E0 (particleboard E1 may be used when MDF stock not available at the time of order).
- Formica E1 (Particleboard)
- Lead times are subject to material availability from our suppliers.

Range 1 Colours – Available in 18 & 25mm



PLEASE NOTE: Due to the variations in computers and printers, some colours may vary. The images provide best representation of the colours available and only serve as a reference to the actual product.

Range 2 Colours

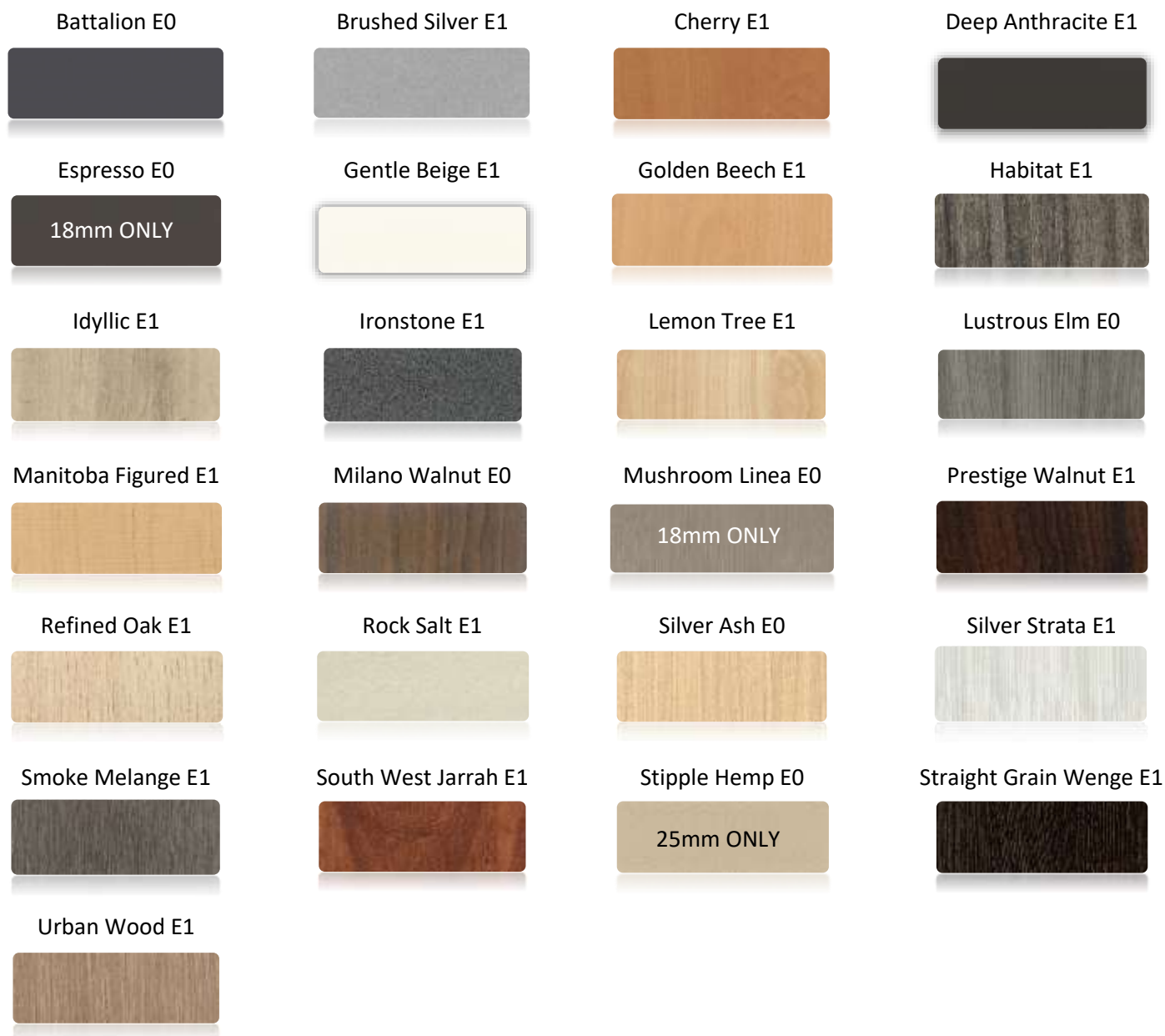

PLEASE NOTE: Due to the variations in computers and printers, some colours may vary. The images provide best representation of the colours available and only serve as a reference to the actual product.

Colours are based on the latest information available at the time of printing and are ***subject to change without notice***

PRICE STRUCTURE - ALL PRICES are subject to 10% GST

- For any items using any colours from Range 1 Standard are priced from R1.
- For any items using any colours from Range 2 are priced from R2.

PLEASE NOTE – Special Sized Standard Product (Length, Depth) to be priced at next size up.

- FOR COMPLETE OFFICE FIT OUTS IN ANY COLOURS PLEASE REQUEST A QUOTE –

LAMINEX – CARE & MAINTENANCE

For general care and maintenance, simply wipe away most spills or marks with a damp cloth, or use an all-purpose cleaner such as Windex spray cleaner or Ajax Spray n Wipe. Rubbing gently with a clean, dry cloth brings back the brightness of laminates. With a few sensible precautions, your Laminex® laminate surface will enjoy a long lifespan.

GENERAL CARE – INFORMATION • Avoid scourers and abrasives as they will damage the surface. • Don't place hot objects, electrical appliances or pots straight from the oven or cooker onto your Laminex laminate surface. • Don't cut on the Laminex laminate surface. • Keep waxes and polishes well away as they dull the natural shine. • Do not use strongly acidic, alkaline cleaners or bleach for normal cleaning as these might etch the surface.

GENERAL CARE – STREAKS Streaky marks sometimes show on dark colours after cleaning. An all-purpose cleaner such as Windex spray cleaner or Ajax Spray n Wipe usually removes them.

GENERAL CARE – GREASE Using a mild dishwashing detergent in water will remove greasy marks. Dab, wait and wipe away. Finish with an all-purpose cleaner such as Windex spray cleaner or Ajax Spray n Wipe.

GENERAL CARE – SPILLS Laminex laminate surfaces resist staining from most household chemicals. With some accidental spills however, prompt action is essential. Wipe off beetroot, grape and berry juices, first aid preparations, concentrated bleach, oven cleaners, dishwasher detergents, artificial dyes, hair colouring and solvent based pen ink immediately. Specialty glues such as Super Glue must also be removed straight away with acetone (nail polish remover).

GENERAL CARE – STAINS If the stain won't budge with Extra Strength Windex, try methylated spirits or dab the stain with a diluted bleach mixture (1 part bleach to 8 parts water); leave for 3 minutes then wash off with water and dry. Finish off with Extra Strength Windex. Only as a last resort if a stain persists try 2 or 3 rubs with a crème cleanser or white toothpaste, wash and dry. Please note that bleach or these abrasive cleaners may irreversibly damage the laminate surface.

GENERAL CARE – SCRATCHES Laminex laminate surfaces will withstand normal wear and tear, but can be damaged by scratching or cutting with utensils, knives and unglazed pottery. Darker colours will show scratches more readily than lighter colours. In general, dark colours and high gloss surfaces require more care and maintenance than lighter colours or lower gloss colours. To minimise scratching, always place and lift objects from the surface – never drag or slide them across the surface.

EDGING – CARE & MAINTENANCE

The use of special synthetic cleaners is recommended for Döllken ABS edgebands. Substances with a high solvent content, and alcoholic substances, should not be used.

WARRANTY

- All products manufactured by MaxwellBeau Pty Ltd are warranted to be free of defects in materials and workmanship for a period of five (5) years from the date of manufacture.
- This Warranty covers replacement or repair of any product defect that is not the result of normal wear and tear.
- Warranty only applies to original purchaser. Rental or loan furniture are not covered under warranty.
- All items must be used for the purpose for which they were designed and built.
- Damage caused by incorrect cleaning methods is not covered by warranty.
- Any modification or alteration to the furniture will void warranty.
- MaxwellBeau Pty Ltd liability is limited to the repair and/or replacement part or parts found to be defective. The cost of freight to and from the factory is at the customers expense.

EXAMPLE OF COMBINATIONS

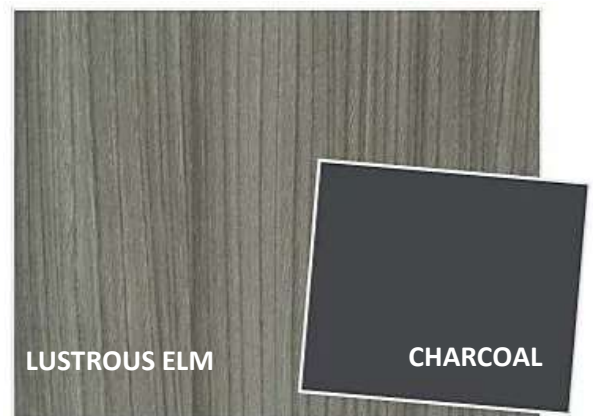
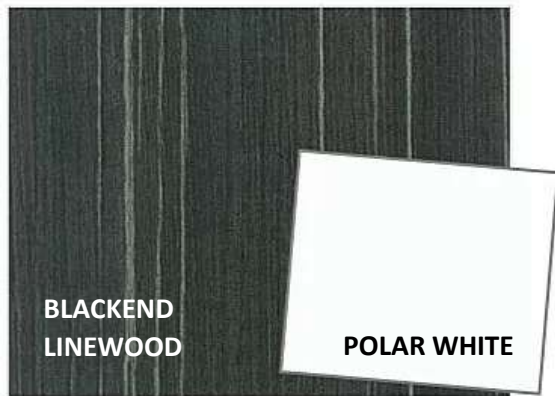

PLEASE NOTE: Due to the variations in computers and printers, some colours may vary. The images provide best representation of the colours available and only serve as a reference to the actual product

DESK - OPEN – NO DRAWERS

Desk overhang – 16mm all around (Front/Back/Sides)



DESCRIPTION

900 x 600 x 725h
1200 x 600 x 725h
1500 x 600 x 725h
1800 x 600 x 725h
2100 x 600 x 725h
2400 x 600 x 725h - with support gable
1200 x 750 x 725h
1500 x 750 x 725h
1800 x 750 x 725h
2100 x 750 x 725h
2400 x 750 x 725h - with support gable
1200 x 900 x 725h
1500 x 900 x 725h
1800 x 900 x 725h
2100 x 900 x 725h
2400 x 900 x 725h - with support gable
Full Modesty Panel up to 1800
Full Modesty Panel over to 1800
Cable Entry add
'D' End on desk top -300mm overhang ADD
Increase desk height to 900h ADD (Also increases modesty)

DESK – with FIXED DRAWER BOX

3 DRAWER OR PEN/FILE DRAWER – NON-LOCKING

Desk overhang – 16mm all around (Front/Back/Sides)

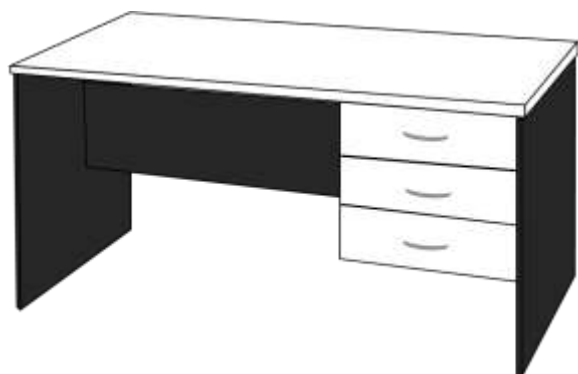

DESCRIPTION

1200 x 600 x 725h
1500 x 600 x 725h
1800 x 600 x 725h
2100 x 600 x 725h
2400 x 600 x 725h – with support gable
1200 x 750 x 725h
1500 x 750 x 725h
1800 x 750 x 725h
2100 x 750 x 725h
2400 x 750 x 725h - with support gable
1200 x 900 x 725h
1500 x 900 x 725h
1800 x 900 x 725h
2100 x 900 x 725h
2400 x 900 x 725h - with support gable
Full Modesty Panel up to 1800
Full Modesty Panel over 1800
Cable Entry add
'D' End on desk top -300mm overhang ADD

FIXED HEIGHT STANDING DESK

Desk overhang – 16mm all around (Front/Back/Sides)
 Height - 1050mm
 25mm Top & gables
 Centre Full Modesty panel or 3/4 modesty panel

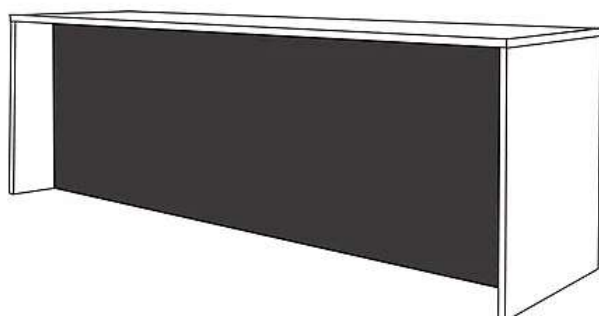

DESCRIPTION

900 x 600 x 1050h
1200 x 600 x 1050h
1500 x 600 x 1050h
1800 x 600 x 1050h
2100 x 600 x 1050h
2400 x 600 x 1050h - with support gable
1200 x 750 x 1050h
1500 x 750 x 1050h
1800 x 750 x 1050h
2100 x 750 x 1050h
2400 x 750 x 1050h - with support gable
1200 x 900 x 1050h
1500 x 900 x 1050h
1800 x 900 x 1050h
2100 x 900 x 1050h
2400 x 900 x 1050h - with support gable
Full to floor Modesty Panel up to 1800
Full to floor Modesty Panel over to 1800
Cable Entry add

BOW FRONT DESK - OPEN

Front overhang – 166mm
 Desk overhang – 16mm all around (Back/Sides)

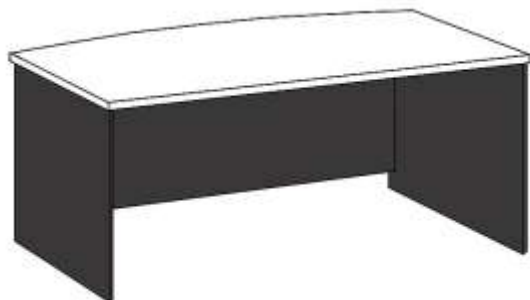

DESCRIPTION

1500 x 750/900 x 725h
1800 x 750/900 x 725h
2100 x 750/900 x 725h
2400 x 750/900 x 725h - with support gable
1500 x 900/1050 x 725h
1800 x 900/1050 x 725h
2100 x 900/1050 x 725h
2400 x 900/1050 x 725h-with support gable
Full Modesty Panel up to 1800
Full Modesty Panel over 1800
Cable Entry add

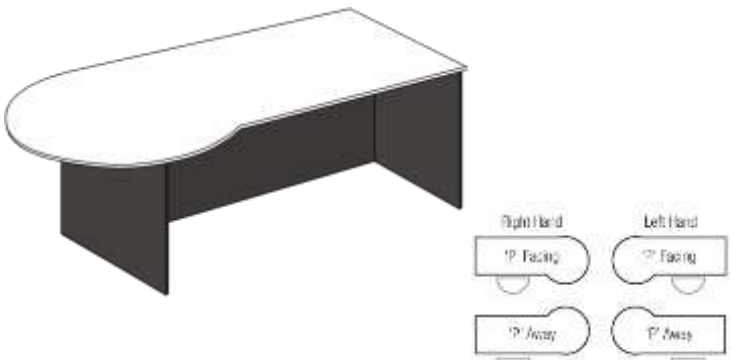
CONFERENCE DESK - OPEN		"P" DESK OVERHANG - 300mm WITH MELAMINE BASE Desk overhang – 16mm all around (Front/Back/Side)
	DESCRIPTION	
	FROM USER SIDE - LHS or RHS / FACING or AWAY	
1800 x 750/900 x 725h		
2100 x 750/900 x 725h		
2400 x 750/900 x 725h		
2300 x 900/1050 x 725h		
2100 x 900/1200 x 725h		
2400 x 900/1200 x 725h		
Full Modesty Panel		
Cable Entry add		

FIXED DRAWER BOXES		462w x 530d x 420h
	DESCRIPTION	
	FROM USER SIDE - LHS or RHS / FACING or AWAY	
1 pen drawer – NON-LOCKING – 462w x 530d x 140h		
3 pen drawers – NON-LOCKING		
1 pen/1 file drawer – NON-LOCKING		
1 pen drawer – LOCKING - 462w x 530d x 140h		
3 pen drawers –LOCKING		
1 pen/1 file drawer –LOCKING		
Extension Runner per file drawer add		

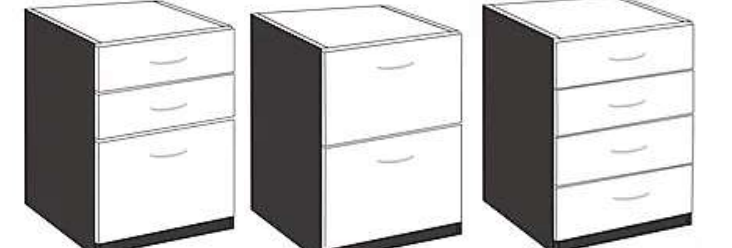
FULL FIXED DRAWER BOXES		TO FLOOR – FOR UNDER DESKS 468w x 530d x 700h
	DESCRIPTION	
	FROM USER SIDE - LHS or RHS / FACING or AWAY	
4 pen drawers – NON-LOCKING		
2 pen/1 file drawer – NON-LOCKING		
2 file drawer – NON-LOCKING		
4 pen drawers –LOCKING		
2 pen/1 file drawer – LOCKING		
2 file drawer – LOCKING		
Extension Runner per file drawer add		

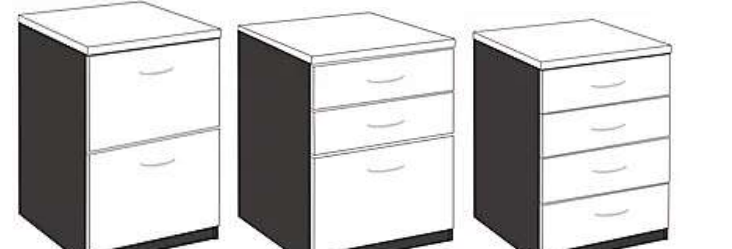
FREE STANDING DRAWER BOXES		468w x 530d x 725h
	DESCRIPTION	
	FROM USER SIDE - LHS or RHS / FACING or AWAY	
4 pen drawers – NON-LOCKING		
2 pen/1 file drawer – NON-LOCKING		
2 file drawer – NON-LOCKING		
4 pen drawers –LOCKING		
2 pen/1 file drawer – LOCKING		
2 file drawer – LOCKING		
Extension Runner for file drawer		

MOBILE PEDESTAL

655h x 468w x 530d

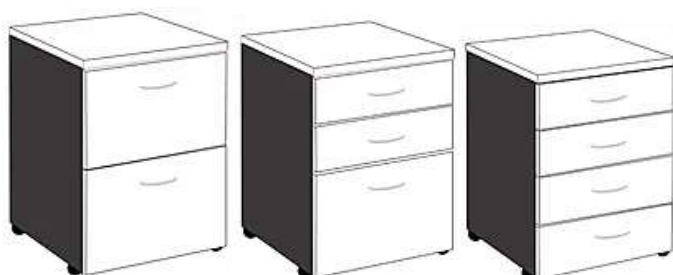
**DESCRIPTION**

4 pen drawers – NON-LOCKING
2 pen/1 file drawer – NON-LOCKING
2 file drawer – NON-LOCKING 690h x 468w x 530d
4 pen drawers –LOCKING
2 pen/1 file drawer – LOCKING
2 file drawer–LOCKING- 690h x 468w x 530d
Extension Runner per file drawer add

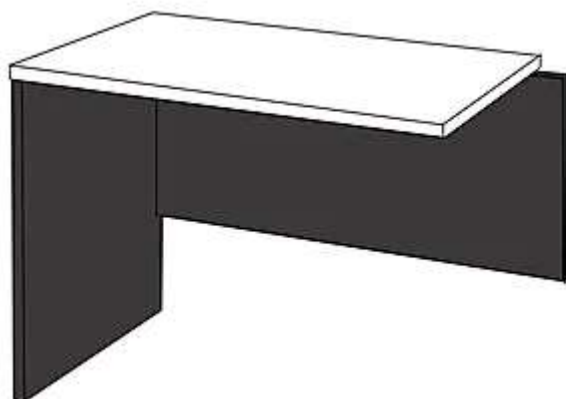
RETURN – OPEN – LHS or RHSCross (Short) Grain on Returns up to 1800mm
Return overhang -16mm on Front/Back/Side**DESCRIPTION**

450mm RETURN - OPEN
900 x 450 x 725h
1200 x 450 x 725h
1500 x 450 x 725h
1800 x 450 x 725h
500mm RETURN – TO FIT DRAWER BOX OR FIXED PEDESTAL with 400mm Drawer
900 x 500 x 725h
1200 x 500 x 725h
1500 x 500 x 725h
1800 x 500 x 725h
600mm RETURN – TO FIT MOBILE PEDESTAL, DRAWER BOX OR FIXED PEDESTAL
900 x 600 x 725h
1200 x 600 x 725h
1500 x 600 x 725h
1800 x 600 x 725h
2100 x 600 x 725h – with support leg
2400 x 600 x 725h – with support leg
Full Modesty Panel up to 1800
Full Modesty Panel over 1800
Free Standing add

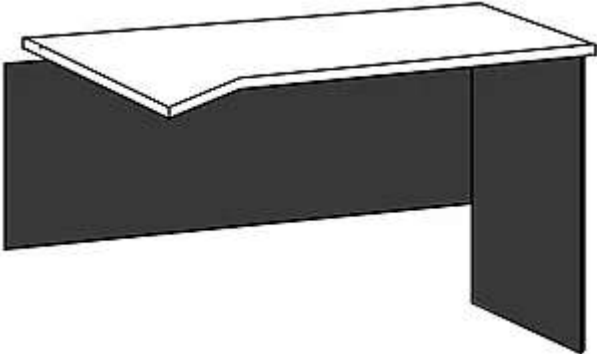
SPLAY RETURN – OPEN–LHS or RHS		SPLAY/KEYBOARD LENGTH 490mm Cross (Short) Grain on Returns up to 1800mm Return overhang -16mm on Front/Back/Side
	DESCRIPTION	
	450mm RETURN - OPEN	
	1200 x 450 x 725h – Splay – 750mm	
	1500 x 450 x 725h – Splay – 750mm	
	1800 x 450 x 725h – Splay – 750mm	
	500mm RETURN – TO FIT DRAWER BOX OR FIXED PEDESTAL WITH 400mm Drawer	
	1200 x 500 x 725h – Splay – 800mm	
	1500 x 500 x 725h – Splay – 800mm	
	1800 x 500 x 725h – Splay – 800mm	
	600mm RETURN – TO FIT MOBILE PEDESTAL, DRAWER BOX OR FIXED PEDESTAL	
	1200 x 600 x 725h – Splay – 900mm	
	1500 x 600 x 725h – Splay – 900mm	
	1800 x 600 x 725h – Splay – 900mm	
	Full Modesty Panel up to 1800	
	Full Modesty Panel over 1800	

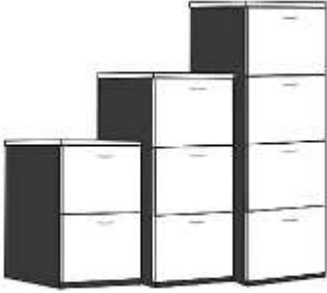
FILING CABINET	
	DESCRIPTION
	2 x DRAWER – 470w x 600d x 725h
	3 x DRAWER – 470w x 600d x 1020h
	4 x DRAWER – 470w x 600d x 1315h
	GANG LOCKED
EXTENSION RUNNERS per drawer	

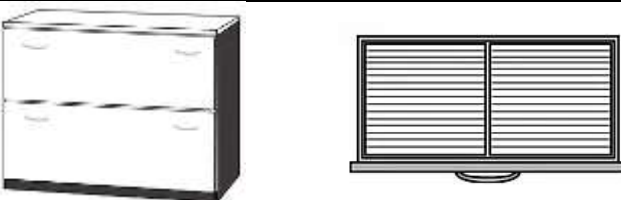
DOUBLE FILING CABINET		FILES RUN FRONT TO BACK
	DESCRIPTION	
	2 x DRAWER – 900w x 600d x 725h	
	3 x DRAWER – 900w x 600d x 1025h	
	DOUBLE GANG LOCKED	
	EXTENSION RUNNERS per drawer	

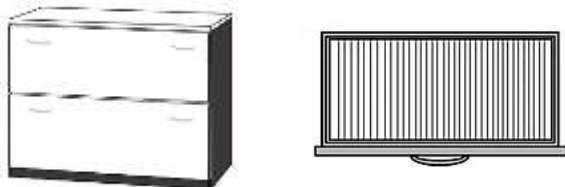
LATERAL FILING CABINET		FULL EXTENSION RUNNERS FILES RUN ACROSS
	DESCRIPTION	
	2 x DRAWER – 900w x 600d x 725h	
	4 x DRAWER – 1800w x 600d x 725h	
	DOUBLE GANG LOCKED	

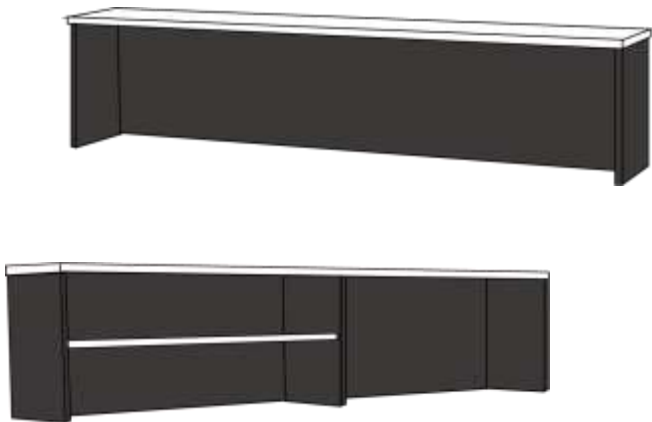
RECEPTION COWL		ATTACHED TO TOP WITH DOUBLE-SIDED TAPE Overhang – 16mm ends/7 ½ mm Front/Back
	DESCRIPTION	
	400mm Clearance	
	1200w x 300d x 425h	
	1500w x 300d x 425h	
	1800w x 300d x 425h	
	2100w x 300d x 425h - centre support	
	2400w x 300d x 425h - centre support	
	Reception Cowl Shelf – ALL SIZES – ADD PER SIDE OF CENTRE DIVISION	
	For Reception Cowl with 450mm Clearance ADD	
	Bow Front add	
Cam Cowl to top		

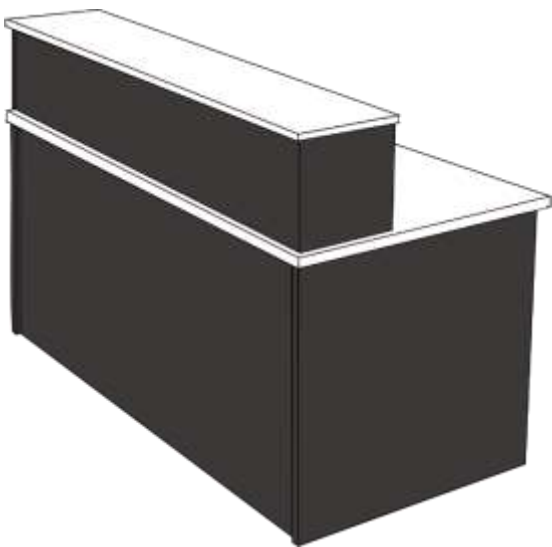
RECEPTION DESK		OPEN DESK/COWL 400mm Clearance/ MODESTY to floor and towards the front/CABLE ENTRY ATTACHED TO TOP WITH DOUBLE-SIDED TAPE Desk overhang – 16mm all around (Front/Back/Sides)/ Cowl Overhang – 16mm ends/7 ½ mm Front/Back
	DESCRIPTION	
	1500 x 600 x 1150h	
	1800 x 600 x 1150h	
	2100 x 600 x 1150h - with support gables	
	2400 x 600 x 1150h - with support gables	
	1200 x 750 x 1150h	
	1500 x 750 x 1150h - with support gable	
	1800 x 750 x 1150h - with support gable	
	2100 x 750 x 1150h - with support gables	
	2400 x 750 x 1150h - with support gables	
	1200 x 900 x 1150h	
	1500 x 900 x 1150h - with support gable	
	1800 x 900 x 1150h - with support gable	
	2100 x 900 x 1150h - with support gables	
	2400 x 900 x 1150h - with support gables	
	Reception Cowl Shelf – ALL SIZES – ADD PER SIDE OF CENTRE DIVISION	
	Reception Cowl – 450mm Clearance ADD	
	Cam Cowl to top	

BOW FRONT RECEPTION DESK

OPEN BOW FRONT DESK/BOW FRONT COWL 400mm Clearance/
 MODESTY TO FLOOR and towards front/CABLE ENTRY
 ATTACHED TO TOP WITH DOUBLE-SIDED TAPE
 Desk overhang – 16mm all around (Back/Sides)
 Cowl Overhang – 16mm ends/7 ½ mm Back



DESCRIPTION

1500 x 750/900 x 1150h
1800 x 750/900 x 1150h
2100 x 750/900 x 1150h - with support gables
2400 x 750/900 x 1150h - with support gables
1500 x 900/1050 x 1150h
1800 x 900/1050 x 1150h
2100 x 900/1050 x 1150h -with support gables
2400 x 900/1050 x 1150h -with support gables
Reception Cowl Shelf – ALL SIZES – ADD PER SIDE OF CENTRE DIVISION
Reception Cowl – 450mm Clearance ADD
Cam Cowl to top

ASCARI RECEPTION DESK

OPEN DESK/COWL 400mm Clearance/ MODESTY to
 floor and towards the front/CABLE ENTRY



DESCRIPTION

2100 x 2100 x 600 x 1150h
2100 x 2100 x 750 x 1150h
2400 x 2400 x 600 x 1150h
2400 x 2400 x 750 x 1150h

CORNER COWL

ATTACHED TO TOP WITH DOUBLE-SIDED TAPE
 SUPPORT GABLE FOR OVER 2100mm
 Cowl Overhang – 16mm ends/7 ½ mm Front/Back



DESCRIPTION

1500 x 1500 x 300d x 425h – 400mm clearance
1800 x 1800 x 300d x 425h – 400mm clearance
2100 x 1800 x 300d x 425h – 400mm clearance
2100 x 2100 x 300d x 425h – 400mm clearance
2400 x 1800 x 300d x 425h – 400mm clearance
2400 x 2100 x 300d x 425h – 400mm clearance
2400 x 2400 x 300d x 425h – 400mm clearance
Reception Cowl Shelf – ALL SIZES – EACH WAY ADD PER SIDE OF CENTRE DIVISION
Reception Cowl – 450mm Clearance ADD
Cam Cowl to top

CORNER RECEPTION DESK

OPEN DESK/COWL 400mm Clearance/ MODESTY to floor and towards the front/CABLE ENTRY
 Desk overhang – 16mm all around (Front/Back/Sides)/ Cowl Overhang – 16mm ends/7 ½ mm Front/Back



DESCRIPTION

1200 x 1200 x 600 x 725h
1500 x 1200 x 600 x 725h
1500 x 1500 x 600 x 725h
1800 x 1200 x 600 x 725h
1800 x 1500 x 600 x 725h
1800 x 1800 x 600 x 725h
2100 x 1200 x 600 x 725h - with support gable
2100 x 1500 x 600 x 725h - with support gable
2100 x 1800 x 600 x 725h - with support gable
1200 x 1200 x 750 x 725h
1500 x 1200 x 750 x 725h
1500 x 1500 x 750 x 725h
1800 x 1200 x 750 x 725h
1800 x 1500 x 750 x 725h
1800 x 1800 x 750 x 725h
2100 x 1200 x 750 x 725h - with support gable
2100 x 1500 x 750 x 725h - with support gable
Reception Cowl – 450mm Clearance ADD
Cam Cowl to top

RECEPTION COUNTER

OPEN DESK/COWL 400mm Clearance/ MODESTY to floor and towards the front/CABLE ENTRY
 Cowl Overhang – 16mm ends/7 ½ mm Front/Sides



DESCRIPTION

1500 x 600 x 1150h
1800 x 600 x 1150h
2100 x 600 x 1150h - with support gables under cowl & desk
2400 x 600 x 1150h - with support gables under cowl & desk
1200 x 750 x 1150h
1500 x 750 x 1150h - with support gable
1800 x 750 x 1150h - with support gable
2100 x 750 x 1150h - with support gables under cowl & desk
2400 x 750 x 1150h - with support gables under cowl & desk
1200 x 900 x 1150h
1500 x 900 x 1150h - with support gable
1800 x 900 x 1150h - with support gable
2100 x 900 x 1150h - with support gables under cowl & desk
2400 x 900 x 1150h - with support gables under cowl & desk
Reception Cowl – 450mm Clearance ADD
Open Return – 1200 x 450 ADD
Open Return – 1200 x 600 ADD

CREST RECEPTION DESK

OPEN DESK/COWL 400mm Clearance/ MODESTY to floor and towards the front/CABLE ENTRY
Cowl Overhang – 16mm ends/7 ½ mm Front/Sides



DESCRIPTION

1500 x 600 x 1150h
1800 x 600 x 1150h
2100 x 600 x 1150h - with support gables under cowl & desk
2400 x 600 x 1150h - with support gables under cowl & desk
1200 x 750 x 1150h
1500 x 750 x 1150h - with support gable
1800 x 750 x 1150h - with support gable
2100 x 750 x 1150h - with support gables under cowl & desk
2400 x 750 x 1150h - with support gables under cowl & desk
1200 x 900 x 1150h
1500 x 900 x 1150h - with support gable
1800 x 900 x 1150h - with support gable
2100 x 900 x 1150h - with support gables under cowl & desk
2400 x 900 x 1150h - with support gables under cowl & desk
Reception Cowl Shelf – ALL SIZES – ADD PER SIDE OF CENTRE DIVISION
Reception Cowl – 450mm Clearance ADD

WORKSTATION – 2 PIECE		CURVED or STRAIGHT KEYBOARD and CNR CABLE ENTRY Keyboard Width – 500mm Desk overhang – 16mm all around (Front/Back/Sides)
	DESCRIPTION	
	2100 x 2100 x 600 x 725h with support gable	
	2400 x 2100 x 600 x 725h with support gable	
	2400 x 2400 x 600 x 725h with support gable	
	2100 x 2100 x 750 x 725h with support gable	
	2400 x 2100 x 750 x 725h with support gable	
	2400 x 2400 x 750 x 725h with support gable	
	Full Modesty Panel up to 1800 per side	
Full Modesty Panel over 1800 per side		

WORKSTATION – OPEN		3 PIECE with corner cable entry Desk overhang – 16mm all around (Front/Back/Sides)
	DESCRIPTION	
	CORNER – 900 x 600 x 900 x 600 – Keyboard width 430mm	
	1500 x 1500 x 600 x 725h	
	1800 x 1500 x 600 x 725h	
	1800 x 1800 x 600 x 725h	
	2100 x 1800 x 600 x 725h - with support gable	
	2100 x 2100 x 600 x 725h - with support gable	
	2400 x 2100 x 600 x 725h - with support gable	
	2400 x 2400 x 600 x 725h - with support gable	
	CORNER – 1050 x 750 x 1050 x 750—Keyboard width 430mm	
	1500 x 1500 x 750 x 725h	
	1800 x 1500 x 750 x 725h	
	1800 x 1800 x 750 x 725h	
	2100 x 1800 x 750 x 725h - with support gable	
	2100 x 2100 x 750 x 725h - with support gable	
	2400 x 2100 x 750 x 725h - with support gable	
	2400 x 2400 x 750 x 725h - with support gable	
Full Modesty Panel up to 1800 per side		
Full Modesty Panel over 1800 per side		
'P' Conference End ADD		

WORKSTATION – 1 PIECE

CURVED or STRAIGHT KEYBOARD and CNR CABLE ENTRY
 Keyboard Width – 500mm
 Desk overhang – 16mm all around (Front/Back/Sides)



DESCRIPTION

1200 x 1200 x 600 x 725h
1500 x 1200 x 600 x 725h
1500 x 1500 x 600 x 725h
1800 x 1200 x 600 x 725h
1800 x 1500 x 600 x 725h
1800 x 1800 x 600 x 725h
2100 x 1200 x 600 x 725h - with support gable
2100 x 1500 x 600 x 725h - with support gable
2100 x 1800 x 600 x 725h - with support gable
1200 x 1200 x 750 x 725h
1500 x 1200 x 750 x 725h
1500 x 1500 x 750 x 725h
1800 x 1200 x 750 x 725h
1800 x 1500 x 750 x 725h
1800 x 1800 x 750 x 725h
2100 x 1200 x 750 x 725h - with support gable
2100 x 1500 x 750 x 725h - with support gable
2100 x 1800 x 750 x 725h - with support gable
Full Modesty Panel up to 1800 per side
Full Modesty Panel over 1800 per side

PIGEON HOLE UNITS

ADJUSTABLE SHELVES

Overhang – 16mm-Front/Sides, 2mm - Back

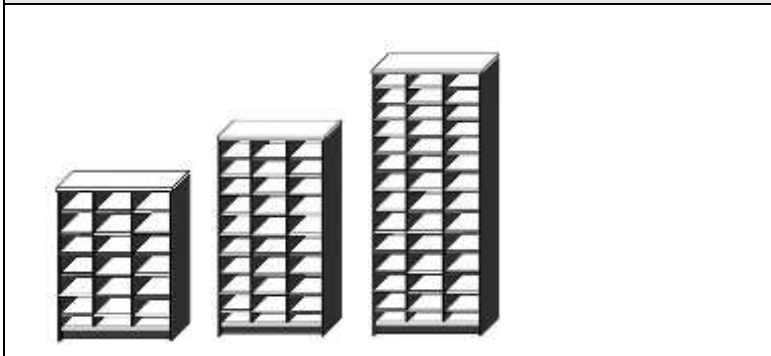

DESCRIPTION

900h x 900w x 350d – 21 Compartments Shelf – 265w x 310d
1250h x 900w x 350d – 30 Compartments Shelf – 265w x 310d
1800h x 900w x 350d – 42 Compartments Shelf – 265w x 310d

DESK/COMPUTER HUTCH

ATTACHED TO TOP WITH DOUBLE-SIDED TAPE
Hutch overhang – 16mm (Front/Sides), 2mm - Back

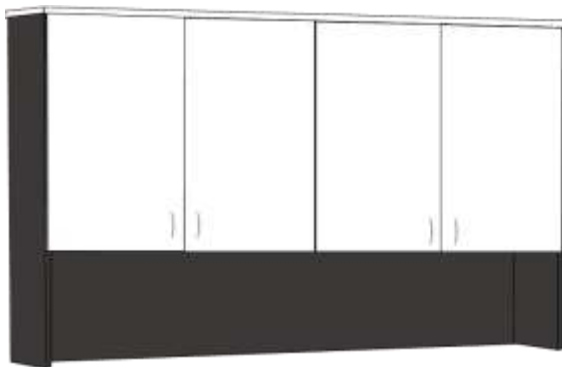
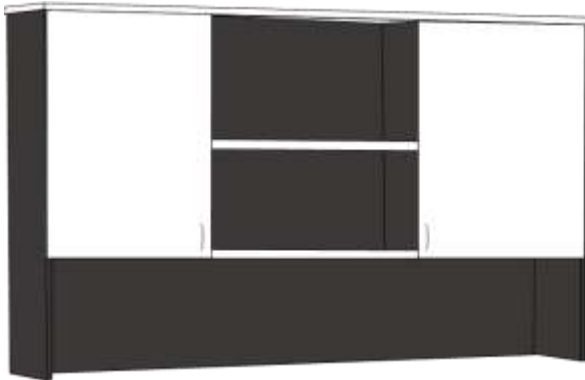

DESCRIPTION

STANDARD -Fixed Bottom Shelf 450mm clearance from desk top for 1075h Hutch

OPTIONAL – Fixed Bottom Shelf 500mm clearance from desk -Please advise when ordering

All have 1 Adjustable 25mm shelf each side of division above fixed 25mm bottom shelf

900w x 1075h x 320d - Shelf depth 280mm

1200w x 1075h x 320d – 1 x Division, Shelf depth 280mm

1500w x 1075h x 320d – 1 x Division , Shelf depth 280mm

1800w x 1075h x 320d – 1 x Division , Shelf depth 280mm

2100w x 1075h x 320d – 2 x Divisions , Shelf depth 280mm

2400w x 1075h x 320d – 2 x Divisions, Shelf depth 280mm

900w x 1075h x 350d - Shelf depth 310mm

1200w x 1075h x 350d – 1 x Division, Shelf depth 310mm

1500w x 1075h x 350d – 1 x Division, Shelf depth 310mm

1800w x 1075h x 350d – 1 x Division, Shelf depth 310mm

2100w x 1075h x 350d – 2 x Divisions, Shelf depth 310mm

2400w x 1075h x 350d – 2 x Divisions, Shelf depth 310mm

900w x 1075h x 400d - Shelf depth 360mm

1200w x 1075h x 400d – 1 x Division, Shelf depth 360mm

1500w x 1075h x 400d – 1 x Division , Shelf depth 360mm

1800w x 1075h x 400d – 1 x Division , Shelf depth 360mm

2100w x 1075h x 400d – 2 x Divisions , Shelf depth 360mm

2400w x 1075h x 400d – 2 x Divisions , Shelf depth 360mm

STANDARD -Fixed Bottom Shelf 450mm clearance from desk top for 1200h Hutch

OPTIONAL – Fixed Bottom Shelf 500mm clearance from desk -Please advise when ordering

All have 1 Adjustable 25mm shelf each side of division above fixed 25mm bottom shelf.

STANDARD CAN FIT 2 x ROWS LEVER ARCH FOLDERS

900w x 1200h x 320d - Shelf depth 280mm

1200w x 1200h x 320d – 1 x Division, Shelf depth 280mm

1500w x 1200h x 320d – 1 x Division, Shelf depth 280mm

1800w x 1200h x 320d – 1 x Division, Shelf depth 280mm

2100w x 1200h x 320d – 2 x Divisions, Shelf depth 280mm

2400w x 1200h x 320d – 2 x Divisions, Shelf depth 280mm

900w x 1200h x 350d , Shelf depth 310mm

1200w x 1200h x 350d – 1 x Division, Shelf depth 310mm

1500w x 1200h x 350d – 1 x Division, Shelf depth 310mm

1800w x 1200h x 350d – 1 x Division, Shelf depth 310mm

2100w x 1200h x 350d – 1 x Division, Shelf depth 310mm

2400w x 1200h x 350d – 1 x Division, Shelf depth 310mm

900w x 1200h x 400d - Shelf depth 360mm

1200w x 1200h x 400d – 1 x Division, Shelf depth 360mm

1500w x 1200h x 400d – 1 x Division, Shelf depth 360mm

1800w x 1200h x 400d – 1 x Division, Shelf depth 360mm

2100w x 1200h x 400d – 2 x Divisions, Shelf depth 360mm

2400w x 1200h x 400d – 2 x Divisions, Shelf depth 360mm

Extra Shelves – 25mm – per shelf

Cam Hutch to top

BOOKCASE HUTCH

CENTRE DIVISION FULL HEIGHT

ATTACHED TO TOP WITH DOUBLE-SIDED TAPE
Hutch overhang – 16mm (Front/Sides), 2mm - Back



DESCRIPTION

All have 2 Adjustable shelves each side of division

900w x 1075h x 320d - Shelf depth 280mm

1200w x 1075h x 320d – 1 x Division, Shelf depth 280mm

1500w x 1075h x 320d – 1 x Division, Shelf depth 280mm

1800w x 1075h x 320d – 1 x Division, Shelf depth 280mm

2100w x 1075h x 320d – 2 x Divisions, Shelf depth 280mm

2400w x 1075h x 320d – 2 x Divisions, Shelf depth 280mm

900w x 1075h x 350d - Shelf depth 310mm

1200w x 1075h x 350d – 1 x Division, Shelf depth 310mm

1500w x 1075h x 350d – 1 x Division, Shelf depth 310mm

1800w x 1075h x 350d – 1 x Division, Shelf depth 310mm

2100w x 1075h x 350d – 2 x Divisions, Shelf depth 310mm

2400w x 1075h x 350d – 2 x Divisions, Shelf depth 310mm

900w x 1075h x 400d - Shelf depth 360mm

1200w x 1075h x 400d – 1 x Division, Shelf depth 360mm

1500w x 1075h x 400d – 1 x Division, Shelf depth 360mm

1800w x 1075h x 400d – 1 x Division, Shelf depth 360mm

2100w x 1075h x 400d – 2 x Divisions, Shelf depth 360mm

2400w x 1075h x 400d – 2 x Divisions, Shelf depth 360mm

900w x 1200h x 320d - Shelf depth 280mm

1200w x 1200h x 320d – 1 x Division, Shelf depth 280mm

1500w x 1200h x 320d – 1 x Division, Shelf depth 280mm

1800w x 1200h x 320d – 1 x Division, Shelf depth 280mm

2100w x 1200h x 320d – 2 x Divisions, Shelf depth 280mm

2400w x 1200h x 320d – 2 x Divisions, Shelf depth 280mm

900w x 1200h x 350d - Shelf depth 310mm

1200w x 1200h x 350d – 1 x Division, Shelf depth 310mm

1500w x 1200h x 350d – 1 x Division, Shelf depth 310mm

1800w x 1200h x 350d – 1 x Division, Shelf depth 310mm

2100w x 1200h x 350d – 2 x Divisions, Shelf depth 310mm

2400w x 1200h x 350d – 2 x Divisions, Shelf depth 310mm

900w x 1200h x 400d - Shelf depth 360mm

1200w x 1200h x 400d – 1 x Division, Shelf depth 360mm

1500w x 1200h x 400d – 1 x Division, Shelf depth 360mm

1800w x 1200h x 400d – 1 x Division, Shelf depth 360mm

2100w x 1200h x 400d – 2 x Divisions, Shelf depth 360mm

2400w x 1200h x 400d – 2 x Divisions, Shelf depth 360mm

Extra Shelves – 25mm – per shelf

Cam Hutch to top

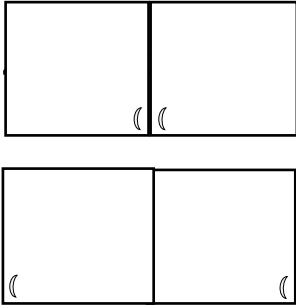
EXTRAS for DESK/COMPUTER HUTCHES		FOR HUTCH CLEARANCE 450 or 500mm
	DESCRIPTION	
	900w Hutch	
	1200w Hutch	
	1500w Hutch	
	1800w Hutch	
	2100w Hutch	
	2400w Hutch	
	Locks per pair of doors	
Extra Shelves – 25mm – per shelf		

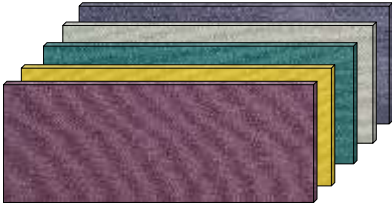
PINBOARDS – FOR HUTCHES AND CADDIES	
	DESCRIPTION
	12mm Board, 6mm Cork, Suzette Fabric.
	900w x 450h
	1200w x 450h
	1500w x 450h
	1800w x 450h
Other sizes and fabric coverings available - P.O.A.	

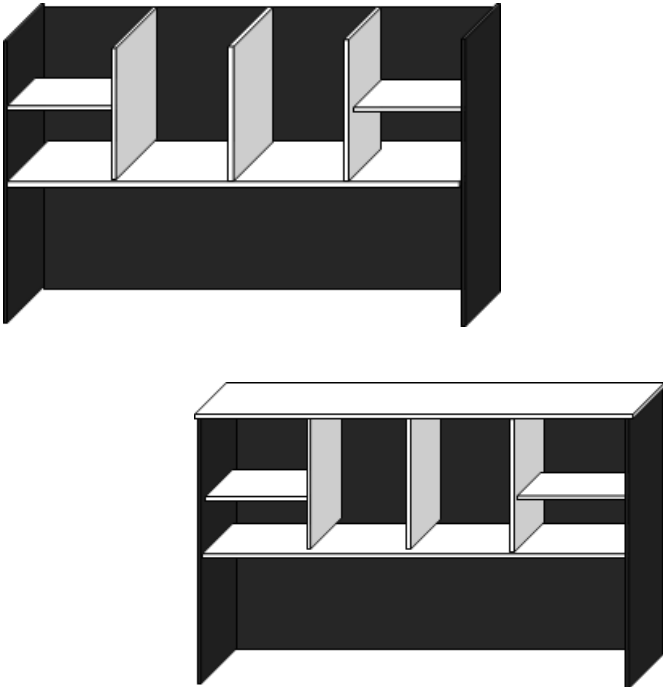
DESK CADDY	WITH VERTICAL DIVISIONS AND SHELF SECTION	
	ATTACHED TO TOP WITH DOUBLE-SIDED TAPE Caddy with top overhang – 16mm-Front/Sides, 2mm - Back	
	DESCRIPTION	
	OPEN – NO TOP – Desk clearance 450mm	
	895w x 800h x 320d – Shelf depth 300mm	
	1195w x 800h x 320d – Shelf depth 300mm	
	1495w x 800h x 320d – Shelf depth 300mm	
	1795w x 800h x 320d – Shelf depth 300mm	
	INCLUDES TOP – Desk clearance 450mm	
	900w x 825h x 320d – Shelf depth 280mm	
	1200w x 825h x 320d – Shelf depth 280mm	
	1500w x 825h x 320d – Shelf depth 280mm	
	1800w x 825h x 320d – Shelf depth 280mm	
	OPEN – NO TOP – Desk clearance 450mm	
	895w x 800h x 400d – Shelf depth 380mm	
	1195w x 800h x 400d – Shelf depth 380mm	
	1495w x 800h x 400d – Shelf depth 380mm	
	1795w x 800h x 400d – Shelf depth 380mm	
	INCLUDES TOP – Desk clearance 450mm	
	900w x 825h x 400d – Shelf depth 360mm	
	1200w x 825h x 400d – Shelf depth 360mm	
	1500w x 825h x 400d – Shelf depth 360mm	
1800w x 825h x 400d – Shelf depth 360mm		
Cam Hutch to top		

CREDENZA – SLIDING DOOR

Overhang – 16mm-Front/Sides, 2mm - Back

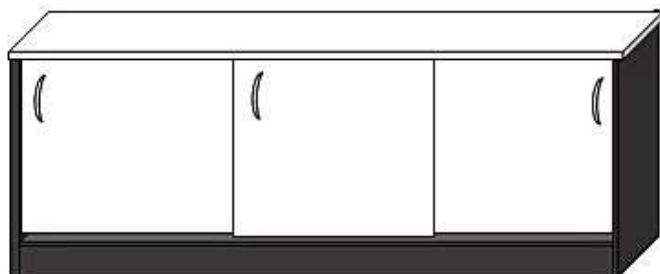
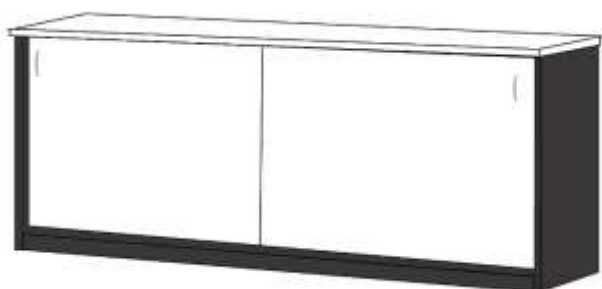

DESCRIPTION

900w x 450d x 725h - Shelf Depth 345mm
1200w x 450d x 725h – Centre Division, Shelf Depth 345mm
1500w x 450d x 725h – Centre Division, Shelf Depth 345mm
1800w x 450d x 725h – Centre Division, Shelf Depth 345mm
2100w x 450d x 725h – 2 Divisions, 3 Sliding Doors, Shelf Depth 345mm
2400w x 450d x 725h – 2 Divisions, 3 Sliding Doors, Shelf Depth 345mm
900w x 600d x 725h - Shelf Depth 495mm
1200w x 600d x 725h – Centre Division, Shelf Depth 495mm
1500w x 600d x 725h – Centre Division, Shelf Depth 495mm
1800w x 600d x 725h – Centre Division, Shelf Depth 495mm
2100w x 600d x 725h – 2 Divisions, 3 Sliding Doors, Shelf Depth 495mm
2400w x 600d x 725h – 2 Divisions, 3 Sliding Doors, Shelf Depth 495mm
2 x SHELVES EACH SIDE OF DIVISION
900w x 450d x 900h - Shelf Depth 345mm
1200w x 450d x 900h – Centre Division, Shelf Depth 345mm
1500w x 450d x 900h – Centre Division, Shelf Depth 345mm
1800w x 450d x 900h – Centre Division, Shelf Depth 345mm
2100w x 450d x 900h – 2 Divisions, 3 Sliding Doors, Shelf Depth 345mm
2400w x 450d x 900h – 2 Divisions, 3 Sliding Doors, Shelf Depth 345mm
900w x 600d x 900h - Shelf Depth 495mm
1200w x 600d x 900h – Centre Division, Shelf Depth 495mm
1500w x 600d x 900h – Centre Division, Shelf Depth 495mm
1800w x 600d x 900h – Centre Division, Shelf Depth 495mm
2100w x 600d x 900h – 2 Divisions, 3 Sliding Doors, Shelf Depth 495mm
2400w x 600d x 900h – 2 Divisions, 3 Sliding Doors, Shelf Depth 495mm
EXTRAS FOR CREDENZAS – 725h ONLY
Extra Shelves – 25mm – per shelf
Lock per pair doors
2 file drawers – Non-Locking add
2 pen/1 file drawer – Non-Locking add
4 pen drawers – Non-Locking add
2 file drawers –Locking add
2 pen/1 file drawer –Locking add
4 pen drawers –Locking add

CREDENZA – HINGED DOOR

Overhang – 16mm-Front/Sides, 2mm - Back



DESCRIPTION

900w x 450d x 725h - 2 x Doors, shelf depth 400mm

1200w x 450d x 725h -1 x div,2 x Doors, shelf depth 400mm

1500w x 450d x 725h - 1 x div, 4 x Doors, shelf depth 400mm

1800w x 450d x 725h-1 x div, 4 x Doors, shelf depth 400mm

2100w x 450d x 725h-3 x div, 4 x Doors, shelf depth 400mm

2400w x 450d x 725h-3 x div, 4 x Doors, shelf depth 400mm

900w x 600d x 725h - 2 x Doors, shelf depth 550mm

1200w x 600d x 725h -1 x div,2 x Doors, shelf depth 400mm

1500w x 600d x 725h- 1 x div, 4 x Doors, shelf depth 550mm

1800w x 600d x 725h- 1 x div, 4 x Doors, shelf depth 550mm

2100w x 600d x 725h- 3x div, 4 x Doors, shelf depth 550mm

2400w x 600d x 725h- 3x div, 4 x Doors, shelf depth 550mm

2 x SHELVES EACH SIDE OF DIVISION

900w x 450d x 900h - 2 x Doors, shelf depth 400mm

1200w x 450d x 900h -1 x div,2 x Doors, shelf depth 400mm

1500w x 450d x 900h-1 x div, 4 x Doors, shelf depth 400mm

1800w x 450d x 900h-1 x div, 4 x Doors, shelf depth 400mm

2100w x 450d x 900h-3 x div, 4 x Doors, shelf depth 400mm

2400w x 450d x 900h-3 x div, 4 x Doors, shelf depth 400mm

900w x 600d x 900h - 2 x Doors, shelf depth 550mm

1200w x 600d x 900h -1 x div,2 x Doors, shelf depth 400mm

1500w x 600d x 900h- 1 x div, 4 x Doors, shelf depth 550mm

1800w x 600d x 900h- 1 x div, 4 x Doors, shelf depth 550mm

2100w x 600d x 900h- 3 x div, 4 x Doors, shelf depth 550mm

2400w x 600d x 900h- 3 x div, 4 x Doors, shelf depth 550mm

EXTRAS FOR CREDENZAS – 725h ONLY

Extra Shelves – 25mm – per shelf

Lock per pair doors

2 file drawers – Non-Locking add

2 pen/1 file drawer – Non-Locking add

4 pen drawers – Non-Locking add

2 file drawers –Locking add

2 pen/1 file drawer –Locking add

4 pen drawers –Locking add

Extension Runners per drawer

WALL UNITS

**CREDENZA with SLIDING OR
HINGED DOORS-BOOKCASE/DESK HUTCH
FOR SPECIFICATIONS REFER TO CREDENZAS and HUTCHES**



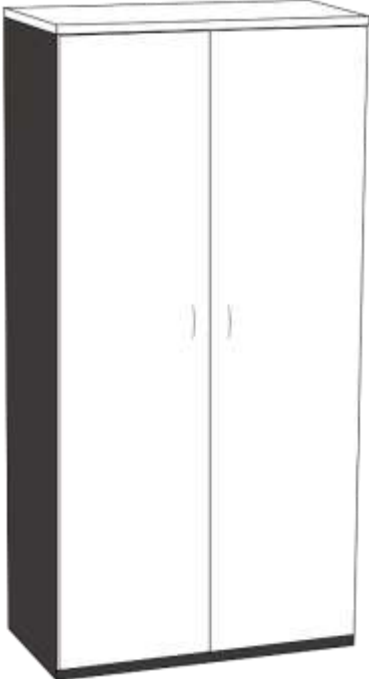

DESCRIPTION	
Credenza 450d x 725h/Hutch 320d	
1800h x 900w	
1800h x 1200w	
1800h x 1500w	
1800h x 1800w	
1800h x 2100w	
1800h x 2400w	
Credenza 450d x 725h/Hutch 350d	
1800h x 900w	
1800h x 1200w	
1800h x 1500w	
1800h x 1800w	
1800h x 2100w	
1800h x 2400w	
Credenza 600d x 725h/Hutch 320d	
1800h x 900w	
1800h x 1200w	
1800h x 1500w	
1800h x 1800w	
1800h x 2100w	
1800h x 2400w	
Credenza 600d x 725h/Hutch 350d	
1800h x 900w	
1800h x 1200w	
1800h x 1500w	
1800h x 1800w	
1800h x 2100w	
1800h x 2400w	
EXTRAS FOR CREDENZAS – 725h ONLY	
Extra Shelves	
Lock per pair doors	
2 file drawers – Non-Locking add	
2 pen/1 file drawer – Non-Locking add	
4 pen drawers – Non-Locking add	
2 file drawers – Locking add	
2 pen/1 file drawer – Locking add	
4 pen drawers – Locking add	

STATIONERY CUPBOARD		Overhang – 16mm-Front/Sides, 2mm - Back
	DESCRIPTION	
	Shelf Depth – 400mm	
	1200h x 900w x 450d - 2 x Adj Shelves	
	1500h x 900w x 450d - 3 x Adj Shelves	
	1800h x 900w x 450d - 3 x Adj, 1 x Fix	
	2100h x 900w x 450d - 4 x Adj, 1 x Fix	
	Shelf Depth – 550mm	
	1200h x 900w x 600d - 2 x Adj Shelves	
	1500h x 900w x 600d - 3 x Adj Shelves	
	1800h x 900w x 600d - 3 x Adj, 1 x Fix	
	2100h x 900w x 600d - 4 x Adj, 1 x Fix	
	CENTRE DIVISION - Shelf Depth – 400mm - TWO (2) shelves each side of division	
	1200h x 1200w x 450d -2 x Adj Shelves (4)	
	1500h x 1200w x 450d -3 x Adj Shelves (6)	
	1800h x 1200w x 450d -3 x Adj, 1 x Fix (8)	
	2100h x 1200w x 450d -4 x Adj, 1 x Fix (10)	
	CENTRE DIVISION - Shelf Depth – 550mm - TWO (2) shelves each side of division	
	1200h x 1200w x 600d -2 x Adj Shelves (4)	
	1500h x 1200w x 600d -3 x Adj Shelves (6)	
	1800h x 1200w x 600d -3 x Adj, 1 x Fix (8)	
2100h x 1200w x 600d -4 x Adj, 1 x Fix (10)		
Extra shelves – 25mm per shelf ADD		
Extra shelves (2) for 1200w each side of division		
Lock per pair doors add		

STATIONERY CUPBOARD		WITH DOORS AT 900h (DOORS SIT ON OUTSIDE) Overhang – 16mm-Front/Sides, 2mm - Back
	DESCRIPTION	
	1200h x 900w x 450d - 1 x Adj Shelves, 1 x Fixed Shelf at 900mm	
	1500h x 900w x 450d - 2 x Adj Shelves, 1 x Fixed Shelf at 900mm	
	1800h x 900w x 450d - 3 x Adj Shelves, 1 x Fixed Shelf at 900mm	
	2100h x 900w x 450d - 4 x Shelves, 1 x Fixed Shelf at 900mm	
	Extra shelves – 25mm per shelf ADD	
	Lock per pair doors add	

COAT CUPBOARD		TOP FIXED SHELF at 300mm from top with HANGING RAIL 1 x DOOR – PLEASE ADVISE HANDLE SIDE WHEN ORDERING Overhang – 16mm-Front/Sides, 2mm - Back
	DESCRIPTION	
	1800h x 600w x 450d – HANGING RAIL RUNS FRONT TO BACK	
	1800h x 450w x 600d	
	1800h x 600w x 600d	
	Locking add	
Full mirror on door - 1200 x 350mm ADD		

STORAGE/COAT CUPBOARD		WITH 450mm STORAGE – 450mm COAT SPACE PLEASE ADVISE COAT SPACE SIDE WHEN ORDERING Overhang – 16mm-Front/Sides, 2mm - Back
	DESCRIPTION	
	Storage section 450w with 4 adjustable shelves – Coat section 450w with fixed shelf 300mm from top	
	1800h x 900w x 600d	
	Full mirror on door - 1200 x 350mm ADD	
	Locking EACH SIDE Add	

UTILITY CUPBOARD		WITH 450mm STORAGE – 450mm COAT SPACE PLEASE ADVISE COAT SPACE SIDE WHEN ORDERING Overhang – 16mm-Front/Sides, 2mm - Back
	DESCRIPTION	
	Storage section 450w with 4 adjustable shelves – Coat section 450w with fixed shelf 300mm from top	
	1800h x 900w x 450d	
	1800h x 900w x 600d	
	Locking EACH SIDE Add	

LOCKERS		Overhang – 16mm-Front/Sides, 2mm – Back Key Locking
	DESCRIPTION	
	2 x Door Locker - 1800h x 450w x 600d	
	3 x Door Locker - 1800h x 450w x 600d	
	4 x Door Locker - 1800h x 450w x 600d	
	Can be hinged either side	

WALL MOUNTABLE BOOKCASES		OPEN TOP -18mm all over Overhang – 2mm Sides, Flush - Back
	DESCRIPTION	
	Shelf Depth 300mm	
	600w x 320d x 300h	
	750w x 320d x 300h	
	900w x 320d x 300h	
	1200w x 320d x 300h	
	1500w x 320d x 300h	
	1800w x 320d x 300h	
	2100w x 320d x 300h	
	2400w x 320d x 300h	

WALL MOUNTABLE BOOKCASES		ANGLED SIDES OPEN TOP -18mm all over Overhang – 2mm Sides, Flush - Back
	DESCRIPTION	
	Shelf Depth 300mm	
	600w x 320d x 300h	
	750w x 320d x 300h	
	900w x 320d x 300h	
	1200w x 320d x 300h	
	1500w x 320d x 300h	
	1800w x 320d x 300h	
	2100w x 320d x 300h	
	2400w x 320d x 300h	

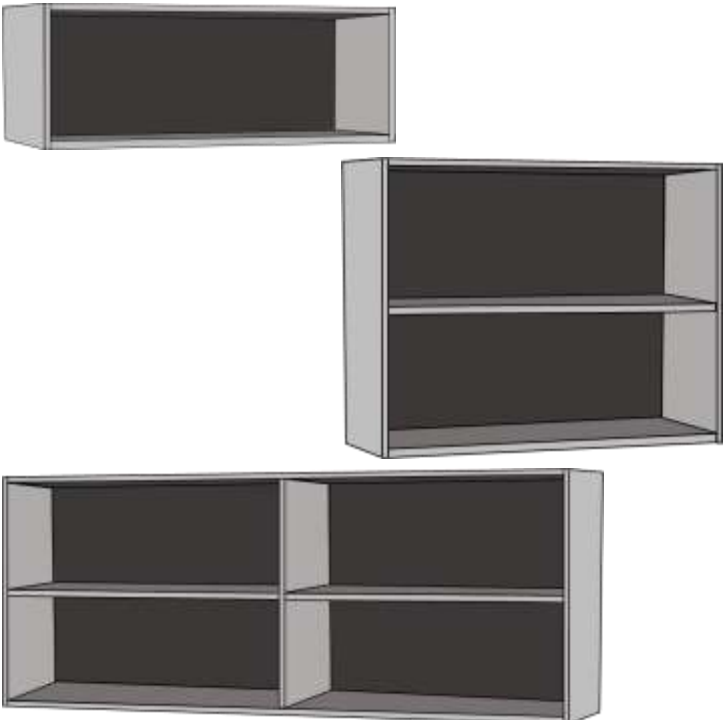
WALL MOUNTABLE BOOKCASES		OPEN WITH TOP – 18mm all over Overhang – 2mm Sides, Flush - Back
	DESCRIPTION	
	Shelf Depth 330mm	
	600w x 350d x 400h	
	750w x 350d x 400h	
	900w x 350d x 400h	
	1200w x 350d x 400h	
	1500w x 350d x 400h	
	1800w x 350d x 400h	
	2100w x 350d x 400h	
	2400w x 350d x 400h	
	Shelf Depth 380mm	
	900w x 400d x 400h	
	1200w x 400d x 400h	
	1500w x 400d x 400h	
	1800w x 400d x 400h	
	Shelf Depth 380mm with 1 adjustable shelf	
	900w x 400d x 800h	
	1200w x 400d x 800h	
1500w x 400d x 800h		
1800w x 400d x 800h		

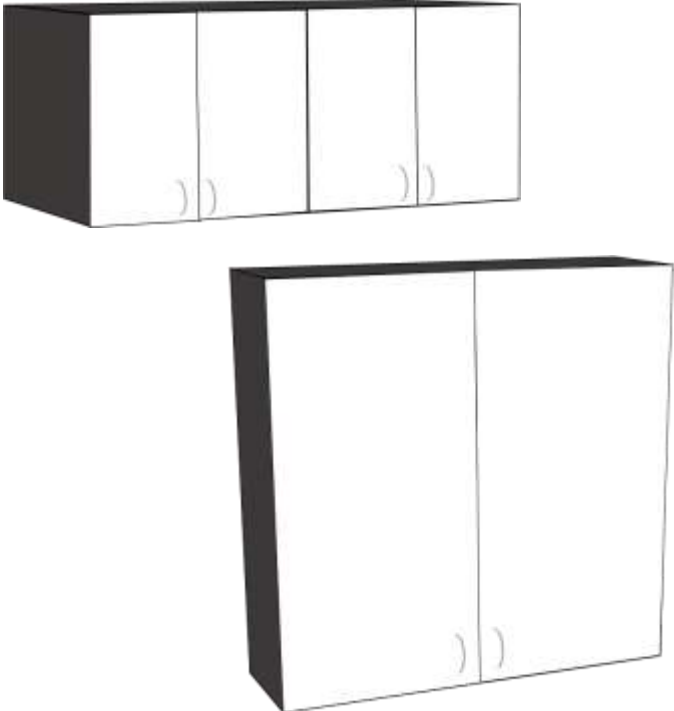
WALL MOUNTABLE CUPBOARDS		Top & Bottom inside gables 18mm all over Flush - Back
	DESCRIPTION	
	Shelf Depth 330mm	
	600w x 350d x 400h	
	750w x 350d x 400h	
	900w x 350d x 400h	
	1200w x 350d x 400h	
	1500w x 350d x 400h	
	1800w x 350d x 400h	
	2100w x 350d x 400h	
	2400w x 350d x 400h	
	Shelf Depth 380mm	
	900w x 400d x 400h	
	1200w x 400d x 400h	
	1500w x 400d x 400h	
	1800w x 400d x 400h	
	Shelf Depth 380mm with 1 adjustable shelf	
	900w x 400d x 800h	
	1200w x 400d x 800h	
1500w x 400d x 800h		
1800w x 400d x 800h		

BOOKCASES – 900w

Overhang – 16mm-Front/Sides, 2mm - Back



DESCRIPTION

725h x 900w x 320d – 1 x Shelf Depth 280mm
900h x 900w x 320d – 2 x Shelves Depth 280mm
1200h x 900w x 320d – 2 x Shelves Depth 280mm
1500h x 900w x 320d – 3 x Shelves Depth 280mm
1800h x 900w x 320d – 4 x Shelves Depth 280mm
2100h x 900w x 320d – 5 x Shelves Depth 280mm
725h x 900w x 350d – 1 x Shelf Depth 310mm
900h x 900w x 350d – 2 x Shelves Depth 310mm
1200h x 900w x 350d – 2 x Shelves Depth 310mm
1500h x 900w x 350d – 3 x Shelves Depth 310mm
1800h x 900w x 350d – 4 x Shelves Depth 310mm
2100h x 900w x 350d – 5 x Shelves Depth 310mm
725h x 900w x 400d – 1 x Shelf Depth 360mm
900h x 900w x 400d – 2 x Shelves Depth 360mm
1200h x 900w x 400d – 2 x Shelves Depth 360mm
1500h x 900w x 400d – 3 x Shelves Depth 360mm
1800h x 900w x 400d – 4 x Shelves Depth 360mm
2100h x 900w x 400d – 5 x Shelves Depth 360mm
Extra shelves – 25mm per shelf ADD

BOOKCASES - 1200w

CENTRE DIVISION – SHELVES EACH SIDE

Overhang – 16mm-Front/Sides, 2mm - Back

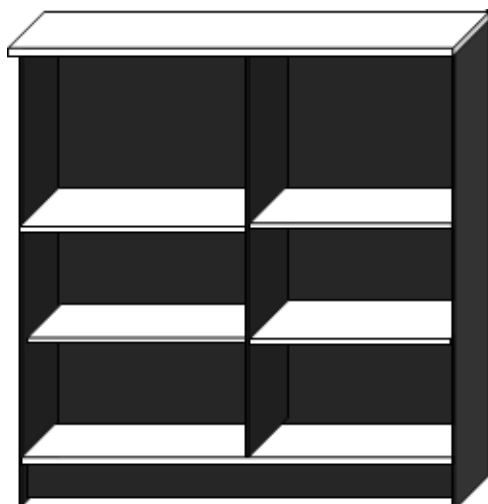

DESCRIPTION

725h x 320d x 1200w – 1x2 Shelves Depth 280mm
900h x 320d x 1200w – 2x2 Shelves Depth 280mm
1200h x 320d x 1200w – 2x2 Shelves Depth 280mm
1500h x 320d x 1200w – 3x2 Shelves Depth 280mm
1800h x 320d x 1200w – 4x2 Shelves Depth 280mm
2100h x 320d x 1200w – 5x2 Shelves Depth 280mm
725h x 350d x 1200w – 1x2 Shelves Depth 310mm
900h x 350d x 1200w – 2x2 Shelves Depth 310mm
1200h x 350d x 1200w – 2x2 Shelves Depth 310mm
1500h x 350d x 1200w – 3x2 Shelves Depth 310mm
1800h x 350d x 1200w – 4x2 Shelves Depth 310mm
2100h x 350d x 1200w – 5x2 Shelves Depth 310mm
725h x 400d x 1200w – 1x2 Shelves Depth 360mm
900h x 400d x 1200w – 2x2 Shelves Depth 360mm
1200h x 400d x 1200w – 2x2 Shelves Depth 360mm
1500h x 400d x 1200w – 3x2 Shelves Depth 360mm
1800h x 400d x 1200w – 4x2 Shelves Depth 360mm
2100h x 400d x 1200w – 5x2 Shelves Depth 360mm
Extra shelves – 25mm per shelf ADD

BOOKCASES – 1500w

CENTRE DIVISION

Overhang – 16mm-Front/Sides, 2mm - Back

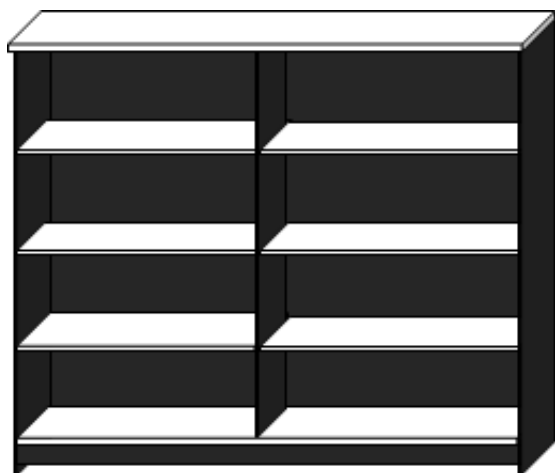

DESCRIPTION

725h x 320d x 1500w – 1x2 Shelves Depth 280mm
900h x 320d x 1500w – 2x2 Shelves Depth 280mm
1200h x 320d x 1500w – 2x2 Shelves Depth 280mm
1500h x 320d x 1500w – 3x2 Shelves Depth 280mm
1800h x 320d x 1500w – 4x2 Shelves Depth 280mm
2100h x 320d x 1500w – 5x2 Shelves Depth 280mm
725h x 350d x 1500w – 1x2 Shelves Depth 310mm
900h x 350d x 1500w – 2x2 Shelves Depth 280mm
1200h x 350d x 1500w – 2x2 Shelves Depth 310mm
1500h x 350d x 1500w – 3x2 Shelves Depth 310mm
1800h x 350d x 1500w – 4x2 Shelves Depth 310mm
2100h x 350d x 1500w – 5x2 Shelves Depth 310mm
725h x 400d x 1500w – 1x2 Shelves Depth 360mm
900h x 400d x 1500w – 2x2 Shelves Depth 360mm
1200h x 400d x 1500w – 2x2 Shelves Depth 360mm
1500h x 400d x 1500w – 3x2 Shelves Depth 360mm
1800h x 400d x 1500w – 4x2 Shelves Depth 360mm
2100h x 400d x 1500w – 5x2 Shelves Depth 360mm
Extra shelves – 25mm per shelf ADD

BOOKCASES – 1800w

CENTRE DIVISION

Overhang – 16mm-Front/Sides, 2mm - Back

1800H and OVER NEEDS TO BE FIXED TO WALL



DESCRIPTION

725h x 320d x 1800w – 1x2 Shelves Depth 280mm
900h x 320d x 1800w – 2x2 Shelves Depth 280mm
1200h x 320d x 1800w – 2x2 Shelves Depth 280mm
1500h x 320d x 1800w – 3x2 Shelves Depth 280mm
1800h x 320d x 1800w – 4x2 Shelves Depth 280mm
2100h x 320d x 1800w – 5x2 Shelves Depth 280mm
725h x 350d x 1800w – 1x2 Shelves Depth 310mm
900h x 350d x 1800w – 2x2 Shelves Depth 310mm
1200h x 350d x 1800w – 2x2 Shelves Depth 310mm
1500h x 350d x 1800w – 3x2 Shelves Depth 310mm
1800h x 350d x 1800w – 4x2 Shelves Depth 310mm
2100h x 350d x 1800w – 5x2 Shelves Depth 310mm
725h x 400d x 1800w – 1x2 Shelves Depth 360mm
900h x 400d x 1800w – 2x2 Shelves Depth 360mm
1200h x 400d x 1800w – 2x2 Shelves Depth 360mm
1500h x 400d x 1800w – 3x2 Shelves Depth 360mm
1800h x 400d x 1800w – 4x2 Shelves Depth 360mm
2100h x 400d x 1800w – 5x2 Shelves Depth 360mm
Extra shelves – 25mm per shelf ADD

MOBILE ITEMS		WITH HEAVY DUTY LOCKING CASTORS Overhang –2mm ALL AROUND
	DESCRIPTION	
	MOBILE CUPBOARD	
	900w x 450d x 725h	
	1200w x 450d x 725h – with centre castor	
	1500w x 450d x 725h – with centre castor	
	1800w x 450d x 725h – with centre castor	
	900w x 450d x 1200h	
	MOBILE CADDY 670h x 530d x 900w with drawers to LHS or RHS	
	Mobile Caddy – OPEN – NON-LOCKING	
	Mobile Caddy – OPEN - LOCKING	
	Mobile Caddy – WITH DOOR – NON-LOCKING	
	Mobile Caddy – WITH DOOR - LOCKING	
	MOBILE HIGH TOWER – 1200h x 470w x 530d Pedestal with open bookcase above	
High Tower – Mobile Pedestal with OPEN bookcase above – NON-LOCKING		
High Tower – Mobile Pedestal with OPEN bookcase above - LOCKING		

COPIER CABINET - MOBILE		DESCRIPTION
	DESCRIPTION	
	600w x 600d x 650h – 1 x Door, 1 x Shelf	
	600w x 600d x 725h – 1 x Door, 2 x Shelves	
	800w x 600d x 650h – 2 x Door, 1 x Shelf	
	800w x 600d x 725h – 2 x Door, 2 x Shelves	
Locking ADD		

STORAGE RACKS		DESCRIPTION
	DESCRIPTION	
	WITH CASTORS	
	900w x 725h x 450d – 6 Compartment with centre castor	
	1200w x 725h x 450d – 8 Compartments with centre castor	
	1200w x 1200h x 450d – 9 Compartments with centre castor	
	ON LEGS	
	900w x 725h x 450d – 6 Compartments with centre castor	
1200w x 725h x 450d – 8 Compartments with centre castor		
1200w x 1200h x 450d – 9 Compartments with centre castor		

STUDY CARRELS

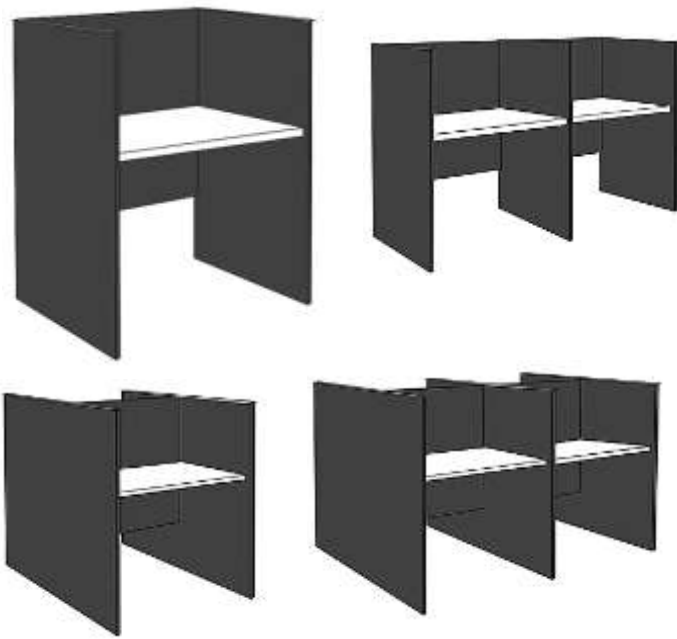

DESCRIPTION

Single
900w x 750d x 1200h

Side-by-side
1800w x 750d x 1200h

Back-to-back
900w x 1500d x 1200h

MOBILE BOOKCASES

DOUBLE SIDED

WITH HEAVY DUTY LOCKING CASTORS

SHELF DEPTH – 290mm each side / Overhang –2mm ALL AROUND
25mm Adjustable shelves

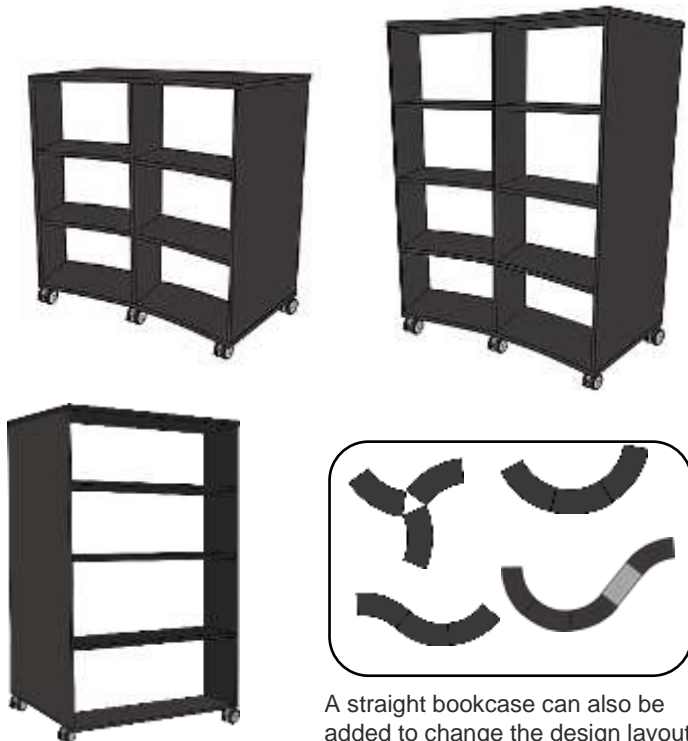

DESCRIPTION

CURVED MOBILE BOOKCASE – DOUBLE SIDED

1200h x 1350w x 600d – Centre division

1540h x 1350w x 600d – Centre division

STRAIGHT MOBILE BOOKCASE – DOUBLE SIDED

1200h x 900w x 600d

1540h x 1350w x 600d – Centre division

MOBILE BOOKCASES		WITH HEAVY DUTY LOCKING CASTORS
SINGLE SIDED	SHELF DEPTH – 302 each side / Overhang –2mm ALL AROUND 25mm Adjustable shelves	
	DESCRIPTION	
	STRAIGHT MOBILE BOOKCASE – SINGLE SIDED	
	900h x 900w x 450d	
	1200h x 900w x 450d	

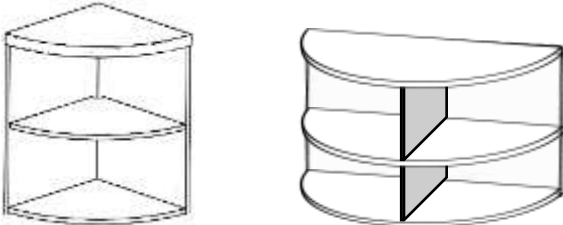
BOOKCASE DESK EXTENSION		
	DESCRIPTION	
	Quarter Bookcase Desk Extension – Fixed Centre Shelf	
	600w x 600d x 725h	
	750w x 750d x 725h	
	Half Bookcase Desk Extension – Fixed Centre Shelf	
	1200w x 600d x 725h 1500w x 750d x 725h	

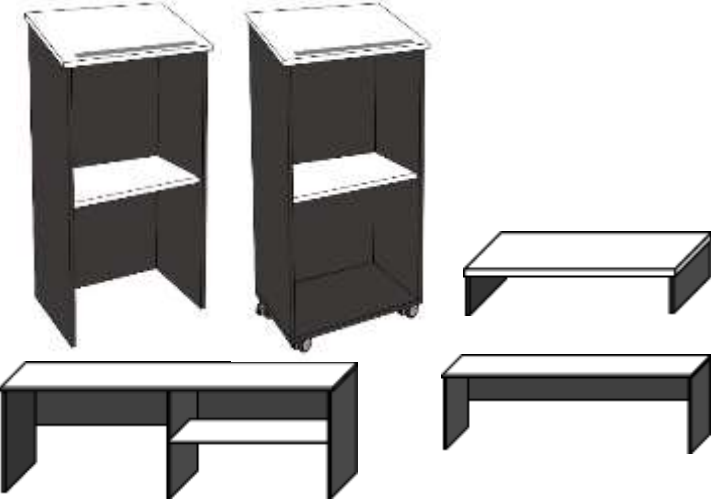
MISCELLANEOUS ITEMS		Overhang – 16mm-Front/Sides, 2mm - Back
	DESCRIPTION	
	LECTURN – 1200h x 600w x 450d with recessed shelf	
	MOBILE LECTURN – 1200h x 600w x 450d with recessed shelf	
	MONITOR STANDS	
	450w x 300d x 175h	
	450w x 300d x 300h	
	600w x 300d x 175h	
	600w x 300d x 300h	
	DESK EXPANDERS	
	900w x 300d x 300h	
	1200w x 300d x 300h	
	1500w x 300d x 300h	
1800w x 300d x 300h		

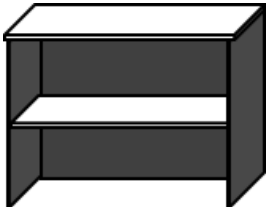
COUNTER		OPEN WITH HORIZONTAL MID CENTRE SHELF & TOP CABLE ENTRY
	DESCRIPTION	
	900w x 600d x 950h	
	1200w x 600d x 950h	

UTILITY COUNTER		WITH OPEN SPACE AND OPEN SHELVING & TOP CABLE ENTRY
	DESCRIPTION	
	<p>1200w x 650d x 950h</p> <hr/> <p>1200w x 650d x 1110h Open Space can take metal 3 drawer filing cabinet Approx. 1020h x 460w x 620d</p>	

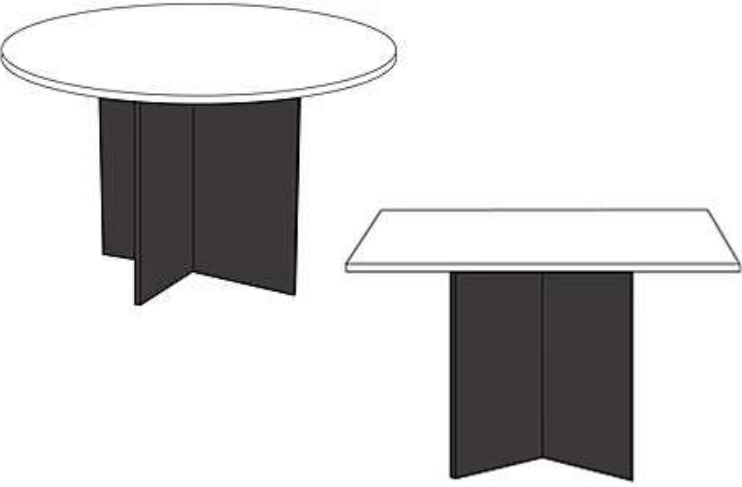
MEETING TABLES – Cruciform Base	
	DESCRIPTION
	750mm dia x 725h – cruciform base
	900mm dia x 725h – cruciform base
	1050mm dia x 725h – cruciform base
	1200mm dia x 725h – cruciform base
	1350mm dia x 725h– cruciform base
	1500mm dia x 725h – cruciform base
	1800mm dia x 725h– cruciform base
	750 x 750 x 725h – cruciform base
	900 x 900 x 725h – cruciform base
	1050 x 1500 x 725h – cruciform base
	1200 x 1200 x 725h – cruciform base
	1350 x 1350 x 725h– cruciform base
	1500 x 1500 x 725h – cruciform base
1800 x 1800 x 725h– cruciform base	

COFFEE TABLES		Overhang – 16mm ALL AROUND
	DESCRIPTION	
	'H' Frame	
	600 x 600 x 450h	
	900 x 600 x 450h	
	1200 x 600 x 450h	
	Gables with Mid-Shelf	
	600 x 600 x 450h -with mid- shelf	
	900 x 600 x 450h -with mid- shelf	
	1200 x 600 x 450h -with mid- shelf	
	Gables and Shelf	
	600 x 600 x 450h -with low- shelf underneath	
	900 x 600 x 450h -with low- shelf underneath	
	1200 x 600 x 450h -with low- shelf underneath	
	Cruciform Base - X	
	600dia x 450h – Cruciform Base	
	750dia x 450h – Cruciform Base	
	900dia x 450h – Cruciform Base	
	PRAGUE DISC BASE – Stainless Steel	
600dia x 455h		
700dia x 455h		
IRIS BASE COFFEE TABLE – Width-550, Height-450, Depth-550		
COLOURS – Black, White, Stainless Steel, Brass		
Suitable for Round Tops 600dia – 800dia		

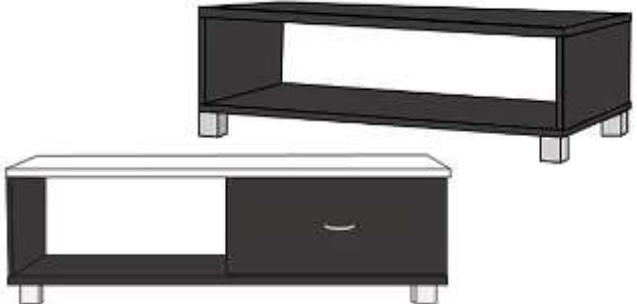
COFFEE TABLES		Overhang – 2mm TOP & BOTTOM
	DESCRIPTION	
	Square Chrome 50mm Feet	
	600 x 600 x 450h	
	900 x 600 x 450h	
	1200 x 600 x 450h	
1200 x 600 x 450h with 1 x drawer		

MEETING TABLES – Disc Base		
 <p>Available in -Stainless Steel -Black</p> <p>Available in -Stainless Steel -Black -White</p>	DESCRIPTION	
	750mm dia x 725h – disc base	
	900mm dia x 725h – disc base	
	1050mm dia x 725h – disc base	
	1200mm dia x 725h – disc base	
	1350mm dia x 725h – disc base	
	1500mm dia x 725h – disc base	
	1800mm dia x 725h – disc base	

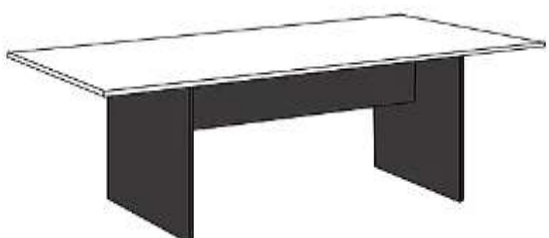
MEETING TABLES	RECTANGULAR TOPS	
	DESCRIPTION	
	H BASES	
	1500w x 750d x 725h	
	1500w x 900d x 725h	
	1500w x 1200d x 725h	
1800w x 750d x 725h		

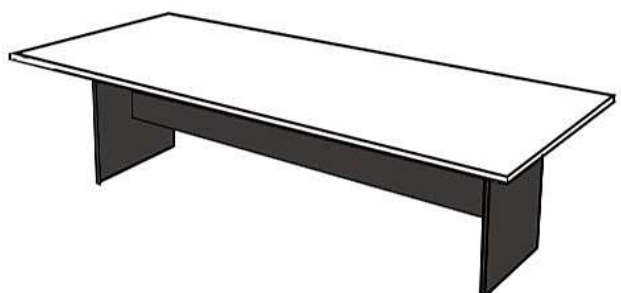
BOARDROOM TABLE	RECTANGLE ON “H” FRAME BASE	
	DESCRIPTION	
	1800w x 900d x 725h – Single Modesty	
	1800w x 1200d x 725h – Single Modesty	
	2100w x 1200d x 725h – Single Modesty	
	2400w x 1200d x 725h – Single Modesty	
	2400w x 1500d x 725h – Double Modesty	
	Over 2400mm – 2 piece Top – Connector plates	
	3000w x 1200d x 725h – Double Modesty	
	3600w x 1200d x 725h – Double Modesty	
	3000w x 1500d x 725h – Double Modesty	
	3600w x 1500d x 725h – Double Modesty	

BOARDROOM TABLE		'D' END, ROUNDED CORNERS, BOAT SHAPED , OVAL, ARC END ON "H" FRAME BASE
	DESCRIPTION	
	1800w x 1200d x 725h – Single Modesty	
	2100w x 1200d x 725h – Single Modesty	
	2400w x 1200d x 725h – Single Modesty	
	2400w x 1500d x 725h – Double Modesty	
	Over 2400mm – 2 piece Top – Connector plates	
	3000w x 1200dx 725h – Double Modesty	
	3600w x 1200d x 725h – Double Modesty	
	3000w x 1500d x 725h – Double Modesty	
	3600w x 1500d x 725h – Double Modesty	

EXTRA FOR BOARDROOM TABLES		
	DESCRIPTION	
	Toggle join for 2 pce Boardroom Tops	
	Data & Power Outlet Cut-outs	
33mm Tops available		

ROUND TOPS – 25mm		
	DESCRIPTION	
	600mm dia	
	750mm dia	
	900mm dia	
	1050mm dia	
	1200mm dia	
	1500mm dia	
1800mm dia		

TABLE BASES	
	DESCRIPTION
	FOLDING LEGS – Black – per pair
	RONDELLA LEGS – Chrome 60mm dia x 690mm high – per leg
	CHROME DISC BASE to take top up to 1200mm
	5 x WAY CHROME BASE to take top up to 1200mm

PANELS AND TOPS CUT TO SIZE AND RE-EDGING AVAILABLE	
	DESCRIPTION
	Price on Request

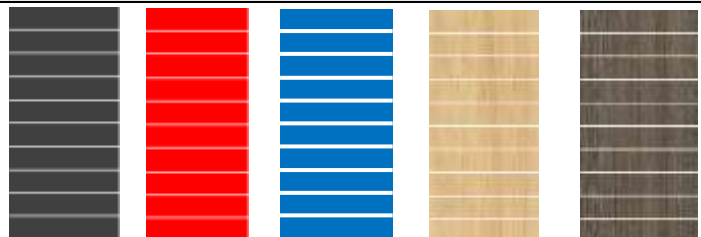
BAY END PANEL – 18mm	
	DESCRIPTION
	Made to size Plain or Woodgrain Custom grooving Panel edging options – Aluminium angle or channel
	Price on Request

PANELS

18mm – EDGED 4 SIDES

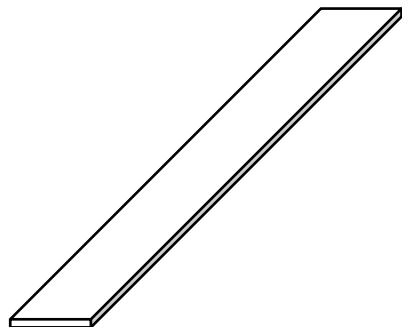
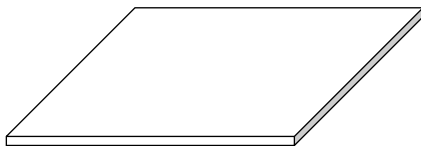
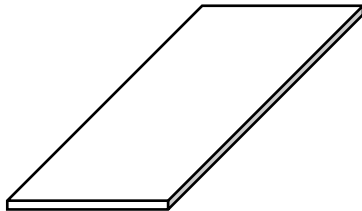

DESCRIPTION

600mm

600w x 300d x 18

600w x 450d x 18

600w x 600d x 18

750mm

750w x 300d x 18

750w x 450d x 18

750w x 600d x 18

750w x 750d x 18

900mm

900w x 300d x 18

900w x 450d x 18

900w x 600d x 18

900w x 750d x 18

900w x 900d x 18

1200mm

1200w x 300d x 18

1200w x 450d x 18

1200w x 600d x 18

1200w x 750d x 18

1200w x 900d x 18

1200w x 1200d x 18

1500mm

1500w x 300d x 18

1500w x 450d x 18

1500w x 600d x 18

1500w x 750d x 18

1500w x 900d x 18

1500w x 1200d x 18

1500w x 1500d x 18

1800mm

1800w x 300d x 18

1800w x 450d x 18

1800w x 600d x 18

1800w x 750d x 18

1800w x 900d x 18

1800w x 1200d x 18

1800w x 1500d x 18

1800w x 1800d x 18

2100mm

2100w x 300d x 18

2100w x 450d x 18

2100w x 600d x 18

2100w x 750d x 18

2100w x 900d x 18

2100w x 1200d x 18

2100w x 1500d x 18

2100w x 1800d x 18

2400mm



2400w x 300d x 18

	2400w x 450d x 18
	2400w x 600d x 18
	2400w x 750d x 18
	2400w x 900d x 18
	2400w x 1200d x 18
	2400w x 1500d x 18
	2400w x 1800d x 18



COMPUTER/WORKSTATION TOPS	WITH CORNER CABLE ENTRY
	DESCRIPTION
	ONE PIECE WORKSTATION TOPS – CURVED/STRAIGHT KEYBOARD SECTIONS
	1200 x 1200 x 600 x 25mm
	1500 x 1500 x 600 x 25mm
	1800 x 1800 x 600 x 25mm
	1200 x 1200 x 750 x 25mm
	1500 x 1500 x 750 x 25mm
	1800 x 1800 x 750 x 25mm
	TWO PIECE WORKSTATION TOPS - TOGGLED
	2100 x 2100 x 600 x 25mm
	2100 x 2100 x 750 x 25mm
	Scallop - 400w x 50d - EACH SIDE ADD

OTHER SHAPED TOPS AVAILABLE	PLEASE ASK FOR SIZES AND A QUOTE
	DESCRIPTION
	KIDNEY SHAPED
	1500 x 800 x 25mm
	1800 x 1000 x 25 mm
	TRAPESIUM
	1200 x 600 x 600 x 600 x 520d x 25mm
	1500 x 750 x 750 x 750 x 650d x 25mm
	CURVED TABLE TOP
	1490w x 1050/450 – 4 x Tables = 2100dia
	1555w x 1100/500 – 4 x Tables = 2200dia
	1700w x 1200/600 – 4 x Tables = 2400dia
	TEACHING TABLE
1800w x 900d x 600	
Shaped Tops available – White Writable	
Straight Tops available – White Magnetic	
RONDELLA LEGS – Chrome	
60mm dia x 690mm high – per leg	

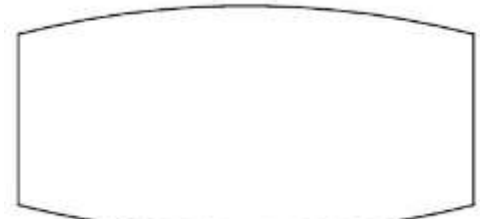
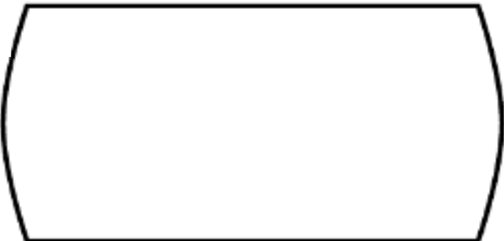
BOARDROOM TABLE TOPS – 25mm

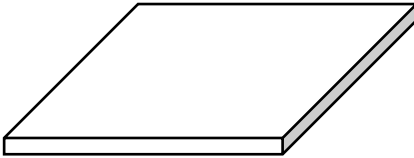
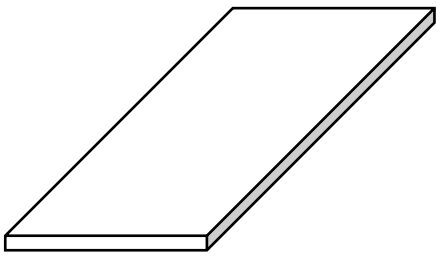
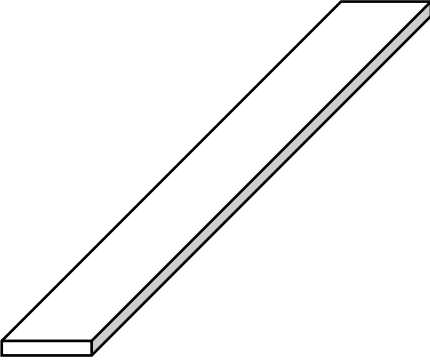
		DESCRIPTION	
	BOARDROOM - RECTANGLE		
	1800w x 900d		
	1800w x 1200d		
	2100w x 1200d		
	2400w x 1200d		
	3000w x 1200d		
	3600w x 1200d		
	2400w x 1500d		
	3000w x 1500d		
	3600w x 1500d		
		BOARDROOM – CURVED CORNERS	
		1800w x 900d	
		1800w x 1200d	
2100w x 1200d			
2400w x 1200d			
3000w x 1200d			
3600w x 1200d			
2400w x 1500d			
3000w x 1500d			
3600w x 1500d			
		BOARDROOM - 'D' END SHAPED	
		1800w x 900d	
		1800w x 1200d	
	2100w x 1200d		
	2400w x 1200d		
	3000w x 1200d		
	3600w x 1200d		
	2400w x 1500d		
	3000w x 1500d		
	3600w x 1500d		
		BOARDROOM - BOAT SHAPED	
		1800w x 800/1000d	
		1800w x 1000/1200d	
2100w x 1000/1200d			
2400w x 1000/1200d			
3000w x 1000/1200d			
3600w x 1000/1200d			
2400w x 1200/1500d			
3000w x 1200/1500d			
3600w x 1200/1500d			
		ARC END	
		1800w x 900d	
		1800w x 1200d	
	2100w x 1200d		
	2400w x 1200d		
	3000w x 1200d		
	3600w x 1200d		
	2400w x 1500d		
	3000w x 1500d		
	3600w x 1500d		

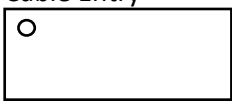
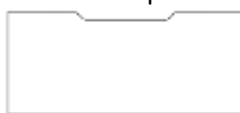
TOPS		25mm – EDGED 4 SIDES
  	DESCRIPTION	
	600mm	600w x 300d x 25
		600w x 450d x 25
		600w x 600d x 25
	750mm	750w x 300d x 25
		750w x 450d x 25
		750w x 600d x 25
		750w x 750d x 25
	900mm	900w x 300d x 25
		900w x 450d x 25
		900w x 600d x 25
		900w x 750d x 25
		900w x 900d x 25
	1200mm	1200w x 300d x 25
		1200w x 450d x 25
		1200w x 600d x 25
		1200w x 750d x 25
		1200w x 800d x 25
		1200w x 900d x 25
		1200w x 1200d x 25
	1500mm	1500w x 300d x 25
		1500w x 450d x 25
		1500w x 600d x 25
		1500w x 750d x 25
		1500w x 800d x 25
		1500w x 900d x 25
		1500w x 1200d x 25
		1500w x 1500d x 25
	1800mm	1800w x 300d x 25
		1800w x 450d x 25
		1800w x 600d x 25
		1800w x 750d x 25
		1800w x 800d x 25
	1800w x 900d x 25	
	1800w x 1200d x 25	
	1800w x 1500d x 25	
	1800w x 1800d x 25	
2100mm	2100w x 300d x 25	
	2100w x 450d x 25	
	2100w x 600d x 25	
	2100w x 750d x 25	
	2100w x 800d x 25	
	2100w x 900d x 25	

<p>D End</p>  <p>Cable Entry</p>  <p>Scallop</p>  <p>Rounded Corners</p> 	2100w x 1200d x 25
	2100w x 1500d x 25
	2100w x 1800d x 25
	2400mm
	2400w x 300d x 25
	2400w x 450d x 25
	2400w x 600d x 25
	2400w x 750d x 25
	2400w x 800d x 25
	2400w x 900d x 25
	2400w x 1200d x 25
	2400w x 1500d x 25
	2400w x 1800d x 25
	Cable Entry 80mm add – PLEASE ADVISE POSITION – 60mm on Request
	Scallop - 400w x 50d
Single Rounded corners - per corner	
To add Bow Front, D End to top add	

We can manufacture table tops to any dimension.

Other Tops available include:

- White Writable Tops
- Magnetic Tops
- Compact Laminate

Edges available include:

- ABS Edge: Very practical edge with attractive 2mm ABS edge to match the top or contrast.
- MDF Polished Edge: Very durable edge. Edge gets sanded with 2 coats of sanding sealer and 2 coats of lacquer.



MAGNETIC

and

writable

Contact us to discuss your requirements.

